

LUPTON

PIVOTED SASH

LUPTON

STEEL PIVOTED WINDOWS
OPERATING DEVICE
COMMERCIAL STEEL DOORS



Catalogue No. 12
Pivoted Window Chapter
3rd Edition

DAVID LUPTON'S SONS COMPANY
Allegheny Avenue and Tulip Street
PHILADELPHIA

Branch offices, agents and dealers in principal cities

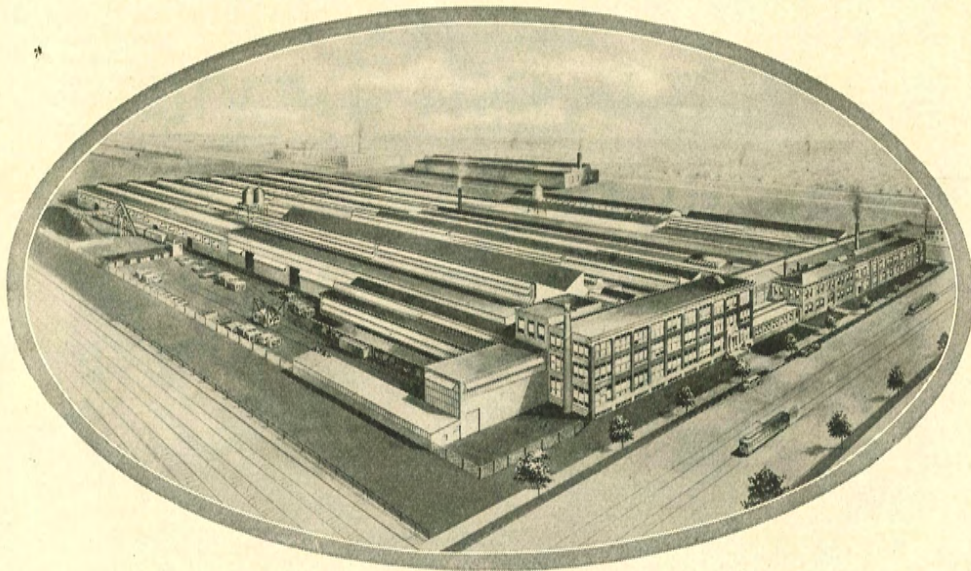

Main Offices and Factory of David Lupton's Sons Co., Philadelphia
Established 1871

**Eleven acres of floor space devoted to the manufacture
of quality steel products.**

Copyright, 1927
David Lupton's Sons Company

CONTENTS

Lupton Pivoted Windows

Horizontally Pivoted

Assembly of Windows	8	Paint	5
Brick Wall Details	12	Sections (Full Size)	7
Building the Walls	21	Sizes, Glass	19
Camber, and Circle Heads	37, 38, 39	Special Windows	18, 19
Concrete Wall Details	13	Specifications	24, 25
Construction	4	Stacking	5
Designing the Walls	20	Standard Sizes	10, 11
Details, Mullions	17	Steel Wall Details	14, 15
Details, Walls		Stock Sizes (Dealer)	9
Brick	12	Superior Features	4
Concrete	13	Symbols for Ordering	9
Steel	14, 15	Terra Cotta Wall Details	16
Terra Cotta	16	Underwriters' Windows	26, 27
Wood	16	Ventilators	4
Erection	22, 23	Wall Building	21
Full Size Sections	7	Wall Designing	20
Glass Sizes	19	Wall Details	
Glazing	22, 23	Brick	12
Hardware	6	Concrete	13
Hinge	6	Steel	14, 15
Information Required with Order	18	Terra Cotta	16
Installations	28 to 36	Wood	16
Lupton Products	52	Wall Opening Measuring Points	17
Measuring Points of Wall Openings	17	Wall Opening Sizes	19
Mullions	5	Window Assembly	8
Mullion Details	17	Window Erection	22, 23
Opening Sizes	19	Window Glazing	22, 23
Ordering—Information Required	18	Window Sizes, Standard	10, 11
Other Products	52	Window Sizes, Dealer Stock	9

Lupton Operating Device

Pivoted Window Operators

Hand Chain Control	41, 42, 43	Hand Wheel Control	44, 45, 46
Description	40	Special Conditions	47

Lupton Commercial Steel Doors

Construction	48	Glass	48
Details and Sizes		Sizes and Details	
Hinged	50	Hinged	50
Sliding	51	Sliding	51
Hardware	48, 49	Sliding Doors, Sizes and Details	51
Hinged Doors, Sizes and Details	50		

Other Lupton Products

Basement Windows	52	Partitions	52
Burvett Steel Doors	52	Pond Continuous Windows	52
Casements, Heavy Type	52	Pond Operating Device	52
Casement Windows, Residence	52	Projected Windows	52
Continuous Windows	52	Skylights	52
Counterbalanced Windows	52	Steel Shelving	52
Double Hung Windows	52	Store, Factory and Office Equipment, Steel	52
Industrial Doors, Steel	52		

Superior Features

Lupton Pivoted Windows

(Horizontally Pivoted)

All members are of low carbon one piece steel sections, designed for necessary strength without needless weight.

Frame members and muntins are assembled with flush joints. The intersection of the mun-

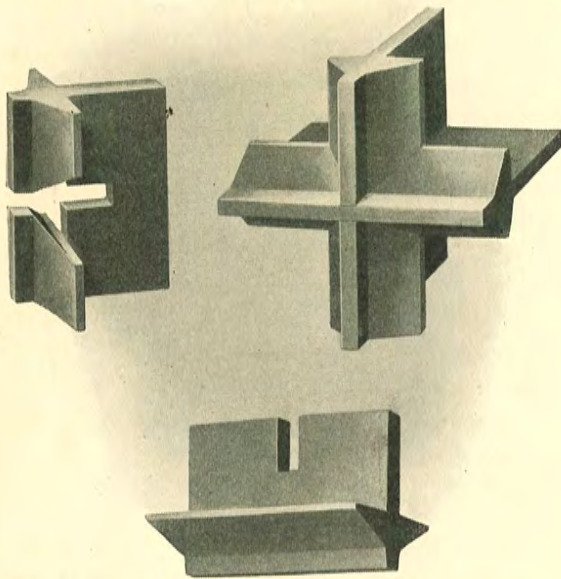

The Lupton Muntin Joint.

tins is illustrated above. The design of the interlock combines most effective placing of metal with the least possible deformation, and its ample strength against both wind pressure and wind suction has been fully demonstrated. The greater the external pressure, the tighter is the lock of the intersecting members. In addition, the Lupton joint gives less opportunity for moisture to enter and cause corrosion.

The ends of the muntins and the corner joints of the frame members are riveted.

All Lupton Dealer Stock and Standard Windows use an angle Section 308 as the frame member. This member makes attachment extremely simple, and gives ample strength in brick and concrete because it has a continuous bearing in the wall. It should be used in

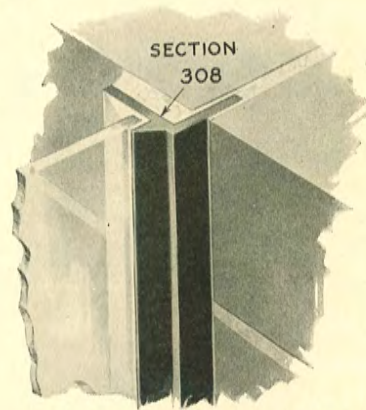

Perspective showing $\frac{5}{8}$ inch lap on flange of window.

all cases, even when the windows are otherwise special.

Ventilators

Ventilators make a 2-point contact all around the enclosed air space, minimizing air leakage.

The weather-tightness of a pivoted ventilator depends on the accuracy of its fit. By making the hinges integral with the structure of the ventilator and window, a permanent close fit is assured.

Ventilators in Dealer Stock and Standard Windows are pivoted 2 inches above center. The hinges are integral with the weathering members, and are reinforced with steel plates riveted to the weathering members. There

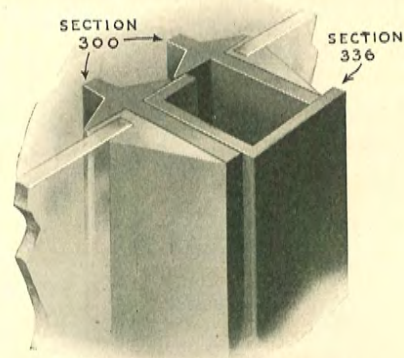

Detail of weathering, showing double contact made by Section 336, and enclosed air space.

are no spacers, hence the hinge pins cannot sag. A continuous double weathering is maintained when the ventilator is closed.

The Lupton Stay Bar *deserves special notice* for its strength and simplicity, and for the secure lock it affords. It is an angle bar, suitably notched and folding back against the window when closed. Because of its shape it is much stronger than a flat bar.

At the option of the purchaser, ventilators are provided with Stay Bar operators, or with Spring Catch and Chain operation. The price for sill length Chain is the same as for Stay Bars. Unless otherwise specified, we furnish Stay Bars on all ventilators except the upper one of a pair, and Spring Catch and Chain operation for upper ventilators. The method of operation should, however, be specified when ordering. For windows with high sills, we furnish a special Chain Clip, No. EL-2365, to be fastened to the wall below the sill.

If desired, Lupton or Pond Operating Device may be added to control the ventilators in lines or groups, at an increase in price.

The locations and sizes of ventilators in Lupton Dealer Stock and Standard Windows are shown on pages 9 and 10. Any departure from these Standards comes under the heading of Special Windows and must be made to order at an increase in price.

Window Cleaners' Anchors

Where window cleaners' anchors are ordered, those made by the Everfast Window Cleaning Device Company, Inc., 62-64 West Washington Street, Chicago, Ill., will be furnished, unless others are specified.

Mullions

T-Bar mullions (Sections 121 and 339) are invariably furnished where mullions are required. They are attached outside the win-

dows with stems projecting either inward or outward. See table on page 17 for limit heights of these mullions; also for details showing placing of mullions and their length when cut.

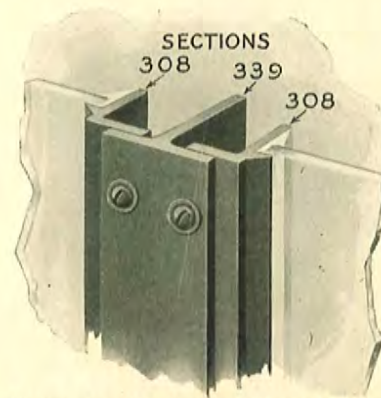

Perspective showing formation of mullion.

The jamb members (Section 308) of all windows are punched with horizontally slotted holes. The mullions have vertically slotted holes. This facilitates erecting and leveling the window.

Paint

Lupton Pivoted Windows are given one shop coat of paint, oven-dried. They should receive at least two coats of paint after erection.

Shipped with Windows

Stay Bars or Spring Catches for ventilators, Glazing Clips and Standard Wall Ties are regularly furnished. Mullions and Mullion Bolts are included when specified. *We do not furnish expansion bolts.* See under "Information Required with the Order", page 18, for items necessary in specifications.

Stacking

Lupton Steel Windows should be carefully stacked as soon as received, by standing the units on edge on three or more level pieces of lumber, such as 3 x 4's, with strongly braced uprights against which the windows may lean. Do not lay windows flat or pile one upon another.

Superior Features

Lupton Pivoted Windows

(Horizontally Pivoted)

All members are of low carbon one piece steel sections, designed for necessary strength without needless weight.

Frame members and muntins are assembled with flush joints. The intersection of the mun-

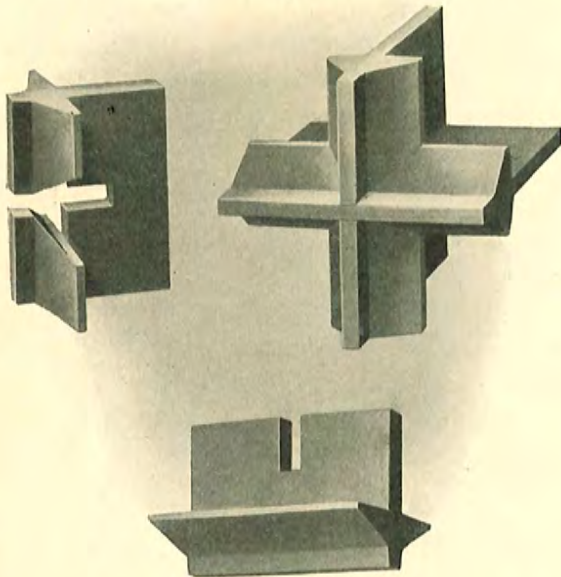

The Lupton Muntin Joint.

tins is illustrated above. The design of the interlock combines most effective placing of metal with the least possible deformation, and its ample strength against both wind pressure and wind suction has been fully demonstrated. The greater the external pressure, the tighter is the lock of the intersecting members. In addition, the Lupton joint gives less opportunity for moisture to enter and cause corrosion.

The ends of the muntins and the corner joints of the frame members are riveted.

All Lupton Dealer Stock and Standard Windows use an angle Section 308 as the frame member. This member makes attachment extremely simple, and gives ample strength in brick and concrete because it has a continuous bearing in the wall. It should be used in

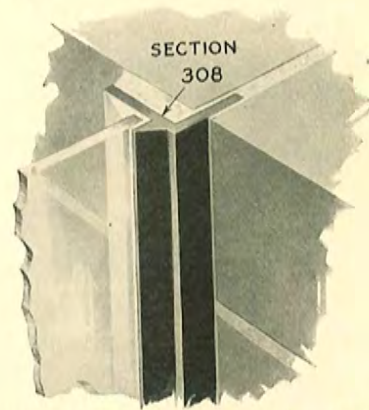

Perspective showing $\frac{1}{8}$ inch lap on flange of window.

all cases, even when the windows are otherwise special.

Ventilators

Ventilators make a 2-point contact all around the enclosed air space, minimizing air leakage.

The weather-tightness of a pivoted ventilator depends on the accuracy of its fit. By making the hinges integral with the structure of the ventilator and window, a permanent close fit is assured.

Ventilators in Dealer Stock and Standard Windows are pivoted 2 inches above center. The hinges are integral with the weathering members, and are reinforced with steel plates riveted to the weathering members. There

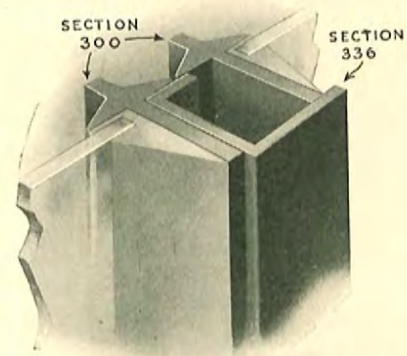

Detail of weathering, showing double contact made by Section 336, and enclosed air space.

LUPTON PIVOTED WINDOWS

are no spacers, hence the hinge pins cannot sag. A continuous double weathering is maintained when the ventilator is closed.

The Lupton Stay Bar *deserves special notice* for its strength and simplicity, and for the secure lock it affords. It is an angle bar, suitably notched and folding back against the window when closed. Because of its shape it is much stronger than a flat bar.

At the option of the purchaser, ventilators are provided with Stay Bar operators, or with Spring Catch and Chain operation. The price for sill length Chain is the same as for Stay Bars. Unless otherwise specified, we furnish Stay Bars on all ventilators except the upper one of a pair, and Spring Catch and Chain operation for upper ventilators. The method of operation should, however, be specified when ordering. For windows with high sills, we furnish a special Chain Clip, No. EL-2365, to be fastened to the wall below the sill.

If desired, Lupton or Pond Operating Device may be added to control the ventilators in lines or groups, at an increase in price.

The locations and sizes of ventilators in Lupton Dealer Stock and Standard Windows are shown on pages 9 and 10. Any departure from these Standards comes under the heading of Special Windows and must be made to order at an increase in price.

Window Cleaners' Anchors

Where window cleaners' anchors are ordered, those made by the Everfast Window Cleaning Device Company, Inc., 62-64 West Washington Street, Chicago, Ill., will be furnished, unless others are specified.

Mullions

T-Bar mullions (Sections 121 and 339) are invariably furnished where mullions are required. They are attached outside the win-

dows with stems projecting either inward or outward. See table on page 17 for limit heights of these mullions; also for details showing placing of mullions and their length when cut.

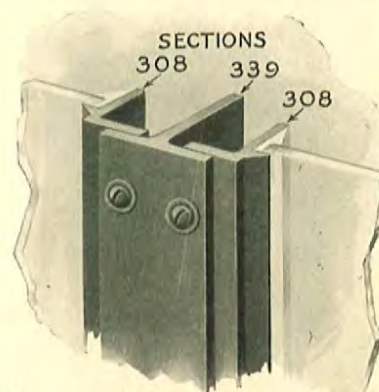

Perspective showing formation of mullion.

The jamb members (Section 308) of all windows are punched with horizontally slotted holes. The mullions have vertically slotted holes. This facilitates erecting and leveling the window.

Paint

Lupton Pivoted Windows are given one shop coat of paint, oven-dried. They should receive at least two coats of paint after erection.

Shipped with Windows

Stay Bars or Spring Catches for ventilators, Glazing Clips and Standard Wall Ties are regularly furnished. Mullions and Mullion Bolts are included when specified. *We do not furnish expansion bolts.* See under "Information Required with the Order", page 18, for items necessary in specifications.

Stacking

Lupton Steel Windows should be carefully stacked as soon as received, by standing the units on edge on three or more level pieces of lumber, such as 3 x 4's, with strongly braced uprights against which the windows may lean. Do not lay windows flat or pile one upon another.

Hardware for Lupton Pivoted Windows

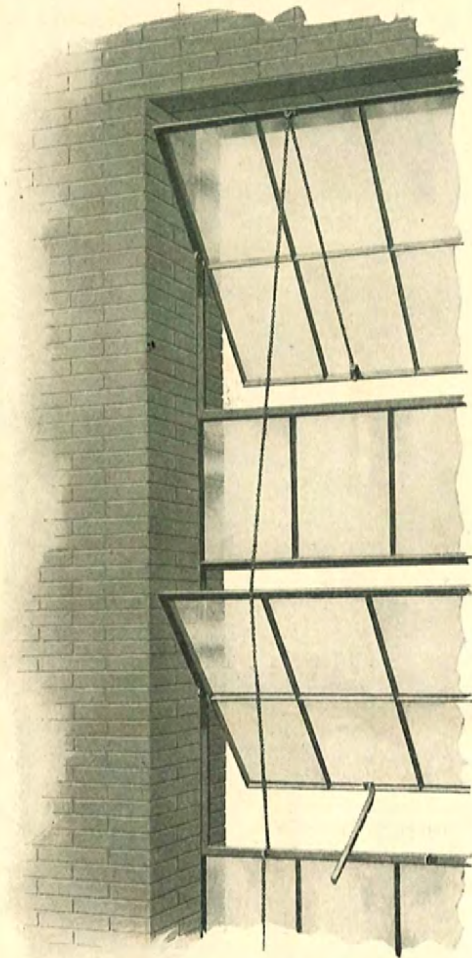

View showing two ventilators in a unit, one above the other. The lower ventilator is operated by Lupton Stay Bar, the upper by Spring Catch and Chain.

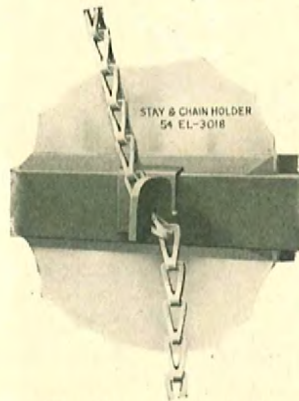

The Clip which holds either Stay Bar or Chain.

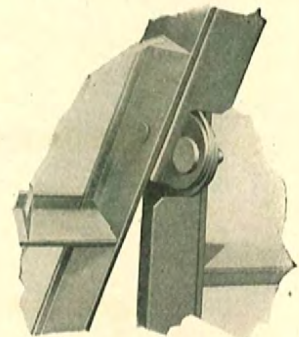

The Lupton Ventilator Hinge. It cannot get out of alignment, being integral with the weathering.

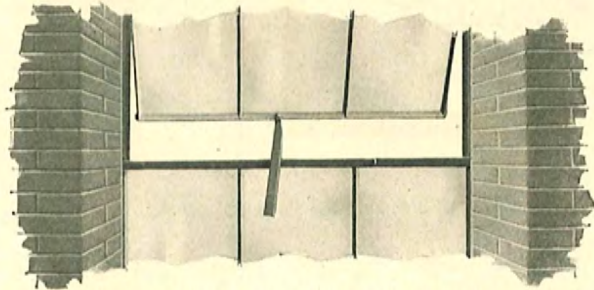

Where ventilators are within reach of the floor, Lupton Stay Bars are regularly furnished.

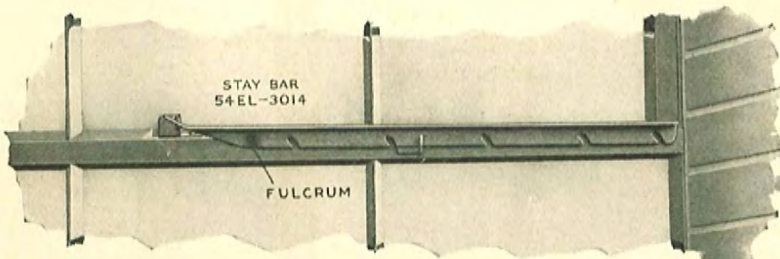

The Lupton Stay Bar in closed position. Location of fulcrum insures a tight lock and five notches are provided for securing the ventilator when open.

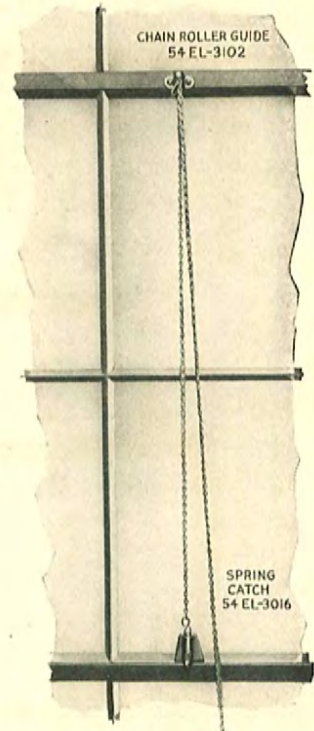

WINDOW SECTIONS - FULL SIZE

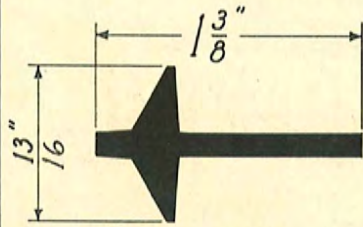

SECTION 300
MUNTIN BAR

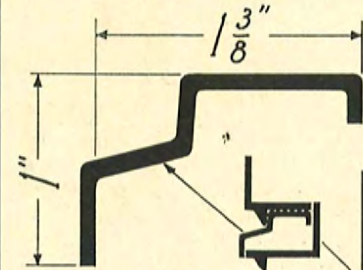

SECTION 335
WEATHERING MEMBER
USED WHEN VENTILATOR
OCCURS AT TOP OF WINDOW

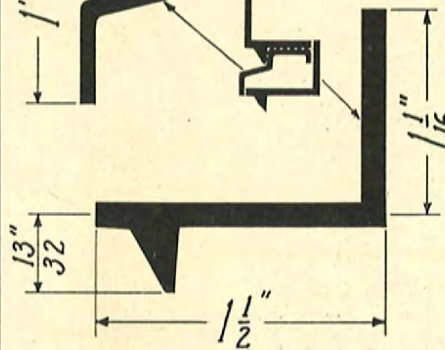

SECTION 318
TOP RAIL OF ALL
VENTILATORS

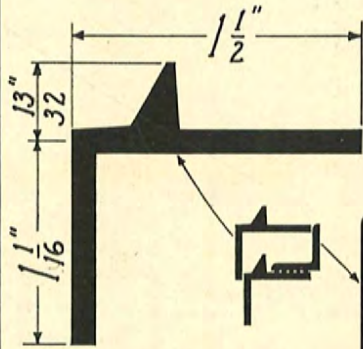

SECTION 319
BOTTOM RAIL OF
ALL VENTILATORS

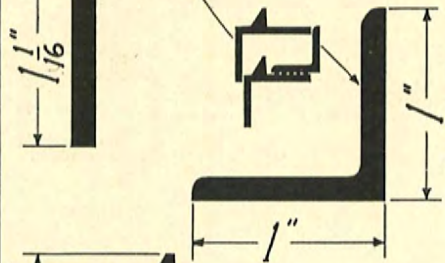

SECTION 103
WEATHERING MEMBER
USED WHEN VENTILATOR
OCCURS AT BOTTOM OF
WINDOW

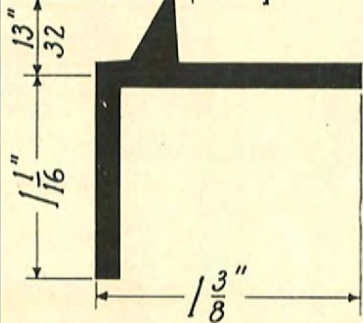

SECTION 308
FRAME MEMBER FOR
ALL DEALER-STOCK,
STANDARD AND
LISTED-SPECIAL
WINDOWS

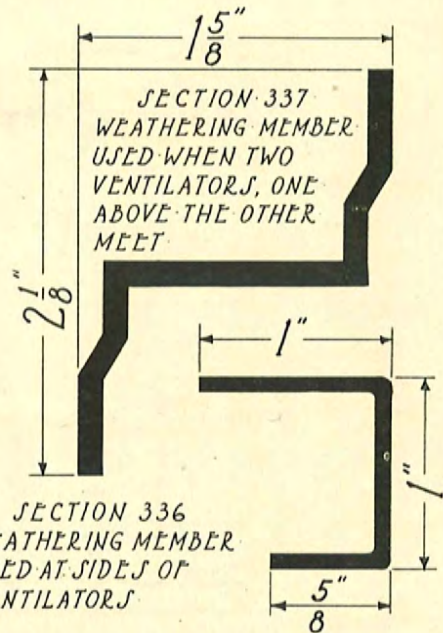

SECTION 337
WEATHERING MEMBER
USED WHEN TWO
VENTILATORS, ONE
ABOVE THE OTHER
MEET

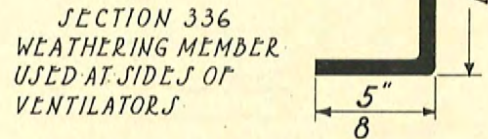

SECTION 336
WEATHERING MEMBER
USED AT SIDES OF
VENTILATORS

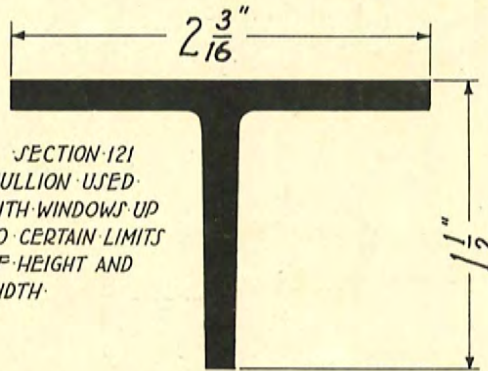

SECTION 121
MULLION USED
WITH WINDOWS UP
TO CERTAIN LIMITS
OF HEIGHT AND
WIDTH

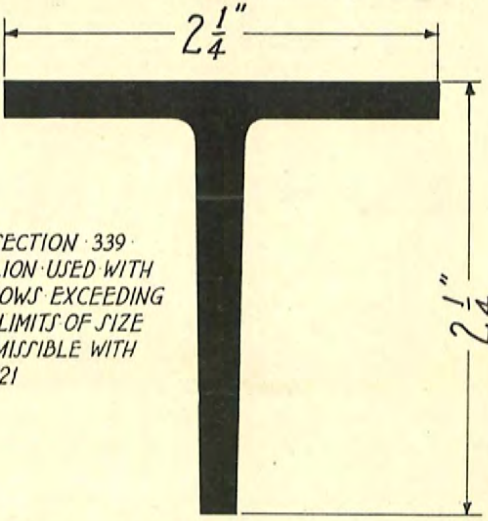





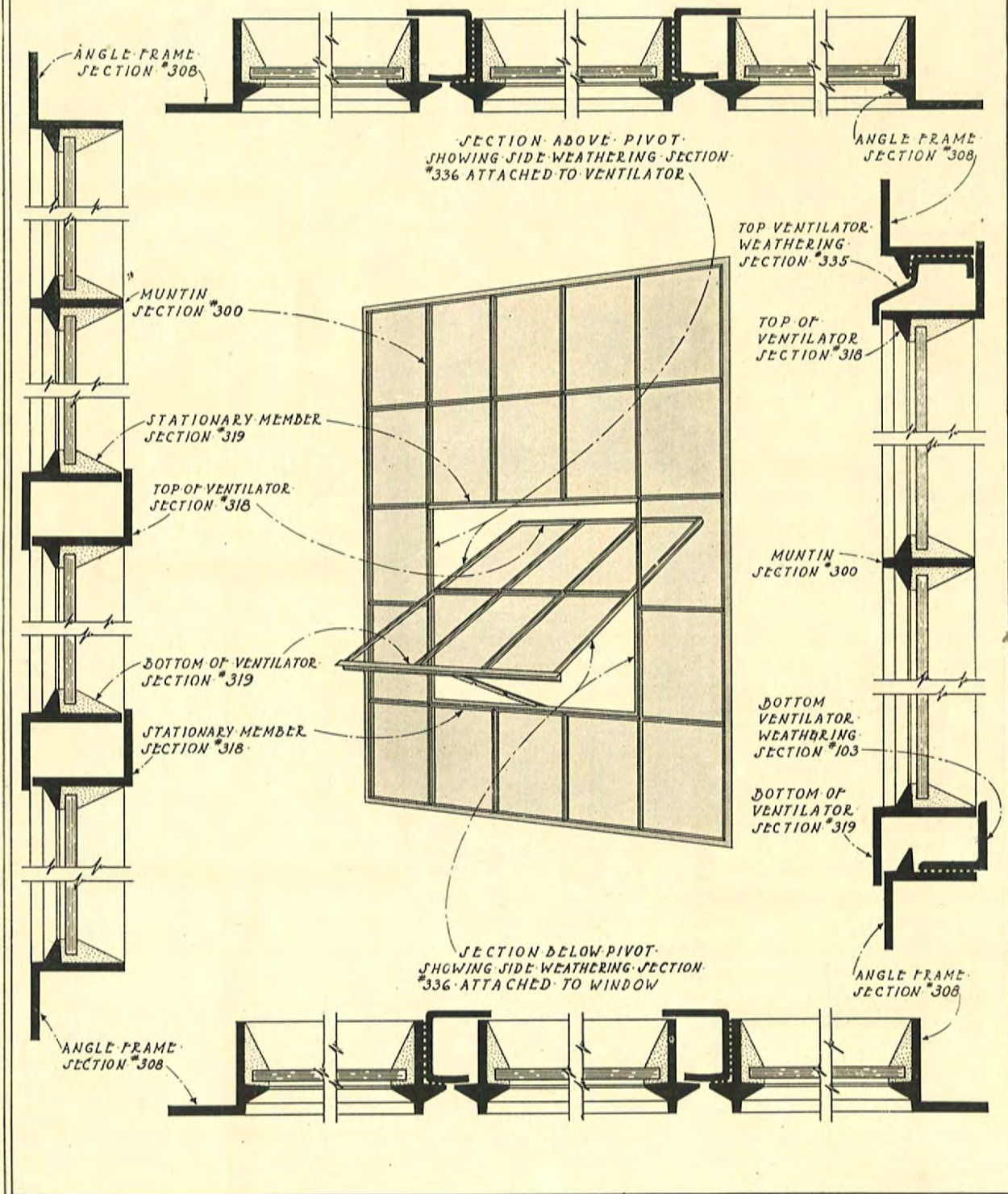















SECTION 339
MULLION USED WITH
WINDOWS EXCEEDING
THE LIMITS OF SIZE
PERMISSIBLE WITH
NO 121

PIVOTED WINDOW DETAILS



Lupton Dealer Stock Window Units for Immediate Delivery

WIDTH.

		2 LIGHTS 2'-1 ⁵ / ₈ "	3 LIGHTS 3'-2" 3'-8"		4 LIGHTS 4'-2 ³ / ₈ " 4'-10 ³ / ₈ "		5 LIGHTS 5'-2 ³ / ₄ " 6'-0 ³ / ₄ "	
HEIGHT.	12"x18" GLASS 14"x20" GLASS							
	2 LIGHTS 5'-1 ⁵ / ₈ " 3'-5 ⁵ / ₈ "		32	32160	42	42180	52	52160
	3 LIGHTS 4'-8" 5'-2"		* 23141					
				33	33161	43	43181	53161
4 LIGHTS 6'-2 ³ / ₈ " 6'-10 ³ / ₈ "								
			34	34161	44181	54161		
5 LIGHTS 7'-8 ³ / ₄ " 8'-6 ³ / ₄ "								
12"x18" GLASS 14"x20" GLASS			35	35161	45181	55161		

* Carried only in 14" x 20" glass size.

DEALER STOCK WINDOWS are the most used sizes of Lupton stationary and pivoted windows in 12 x 18 and 14 x 20 in. glass sizes. They are strictly standard in construction and are carried completely assembled and ready for shipment by Lupton agents and dealers throughout the country.

Lupton Dealer Stock Windows should always be used where possible in preference to Standard, but non-stock sizes. They cost no more and can be delivered immediately.

Lupton Standard Windows include all those sizes and ventilator arrangements in common use. They are not assembled in advance, but large stocks of the cut bars are always carried in our factory ready for quick assembly.

Symbols Used to Designate Windows

The following information is given you so that you can intelligently order Lupton Pivoted Windows by following layouts shown on this and the next page.

Dimensions in inches preceding window unit nomenclature indicates glass size, namely 12" x 18" and 14" x 20".

All other glass sizes are special.

Numerals of nomenclature indicate the following:

First Numeral—number of lights wide.

Second Numeral—number of lights high.

Third Numeral—number of ventilators.

Fourth Numeral—number of lights per ventilator.

Fifth Numeral—number of stationary lights high between bottom of window and bottom of ventilator.

Sixth Numeral—number of lights high between bottom of window and bottom of upper ventilator.

Examples: 14/20 56 indicates a unit taking 14" x 20" glass, five lights wide, six lights high, stationary. 14/20 45181 is a unit taking 14" x 20" glass, four lights wide, five lights high, having one (1) eight (8) light ventilator, one (1) light high between bottom of window and bottom of ventilator. 12/18 562614 is a unit taking 12" x 18" glass, five lights wide, six lights high, having two (2) six (6) light ventilators, having one (1) light high between bottom of window and bottom of lower ventilator.

STANDARD WINDOW UNITS.

SIZES SHADED ARE DEALER STOCK SIZES.

	2 LIGHTS		3 LIGHTS		4 LIGHTS		5 LIGHTS		6 LIGHTS	
	12"x18" GLASS 2'-1 3/8"	14"x20" GLASS 2'-5 3/8"	3'-2"	3'-8"	4'-2 3/8"	4'-10 3/8"	5'-2 3/4"	6'-0 3/4"	6'-3 3/8"	7'-3 1/8"
	3'-1 1/8"	3'-5 5/8"								
WIDTH										
2 LIGHTS	32	32160	42	42140	42180	52	52160	62180		
3 LIGHTS	33	33161	43	43141	43181	53	53161	63181		
4 LIGHTS	34	34161	44	44141	44181	54	54161	64181		
5 LIGHTS	35	35161	35162	45	45141	45181	45182	55	55161	55162
6 LIGHTS	36	36161	362614	46	46141	46181	462814	56	56161	562614
7 LIGHTS			372614	47			472814		572614	
HEIGHT	7'-0 3/4"	8'-6 3/4"								
12"x18" GLASS										
14"x20" GLASS										

and four (4) lights between bottom of window and bottom of upper ventilator.

Indicate the number of window units in each wall opening by writing such number before the window symbol. For example, 2 openings 3-12/18 46181 indicates that for

each of 2 openings 3 units are required of the window symbol given. Consequently, 2 mullion bars are needed for each opening. Sometimes units of different widths or having different ventilators are used to fill in opening. For example, 2-12/18 36; 2-12/18 56161; 1-12/18 46183.

LUPTON PIVOTED WINDOWS

LUPTON STANDARD PIVOTED WINDOWS comprise all units shown on page 10 in 12 x 18 and 14 x 20 in. glass. Cut members of those units are carried regularly in stock at the factory, ready for assembling. By combining suitable units and taking advantage of high and low ventilator locations, all ordinary requirements can be met.

Certain sizes of Lupton Pivoted Windows are in sufficient demand to be carried completely assembled in dealer stock. When so assembled, they are known as Dealer Stock

Windows. These sizes are shown on pages 9 and 10. There is no difference in the quality or price between Stock and Standard Windows, but the former can be delivered immediately.

Unless otherwise specified, Stay Bars are furnished for all ventilators except the upper one of a pair. It is always better to specify operators desired, also sill height. See "Information Required with the Order," page 18. Order by symbols appearing under the units. See pages 9 and 10 for explanation of symbols. Always specify glass sizes wanted.



As mentioned in the text, we carry at all times a large stock of standard bars ready for assembling into window units as soon as your order is received. The view above shows a section of the Lupton Bar Stock storage. In addition to this large stock of standard bars, certain units shown on page 9 are carried in stock in our warehouses and also many dealer warehouses throughout the country. The wide selection of our standard stock sizes permits us to fill quickly most all Pivoted Window requirements.

WALL DETAILS
BRICK

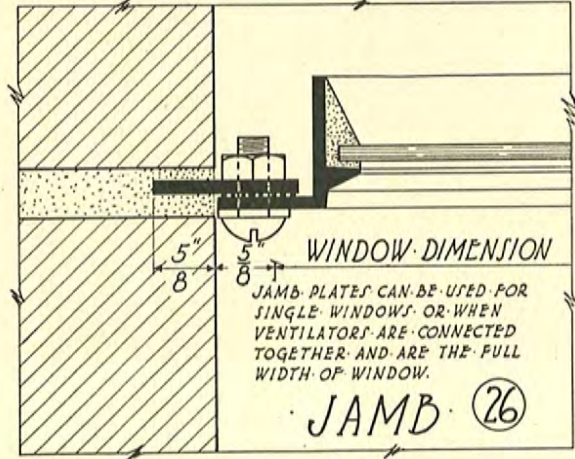
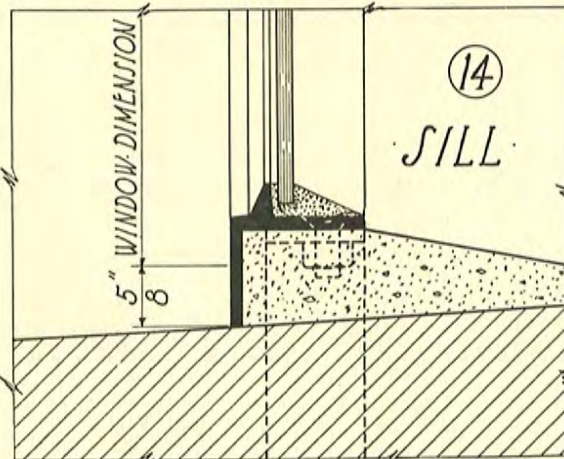
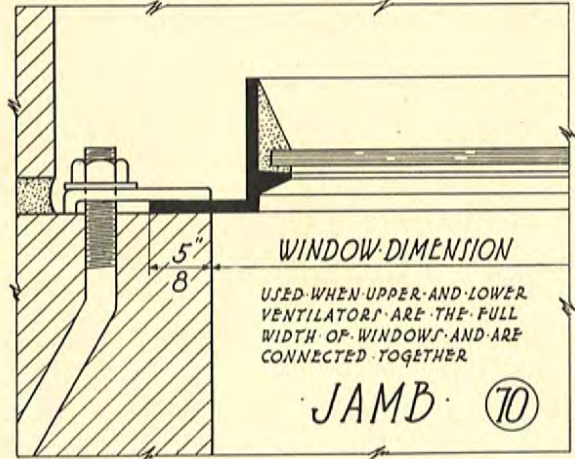
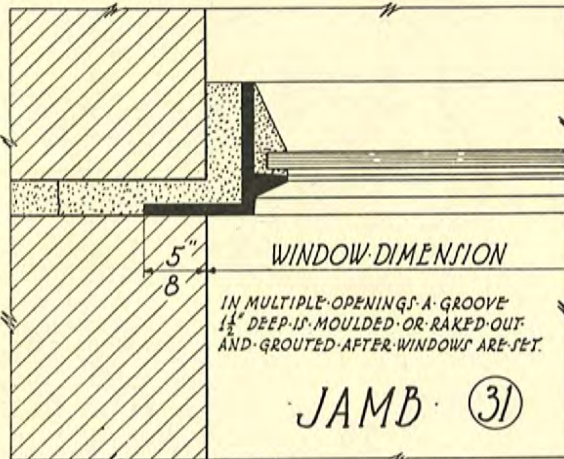
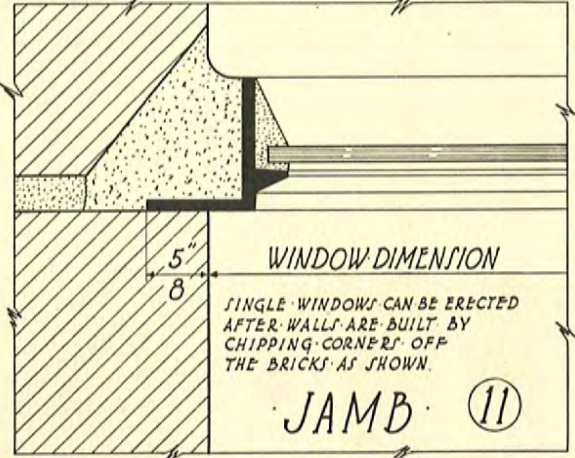
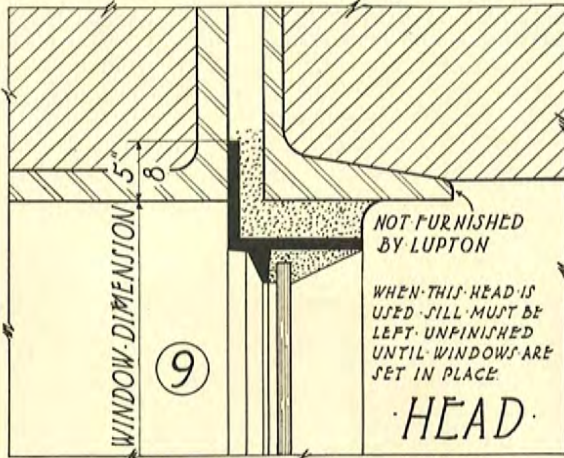

DETAILS ARE ONE-HALF FULL SIZE

WALL DETAILS
CONCRETE

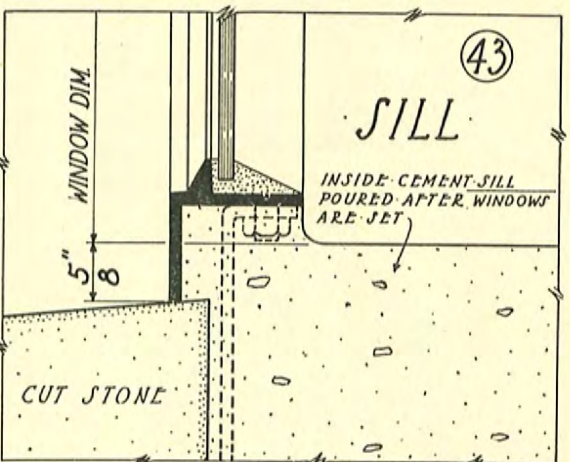
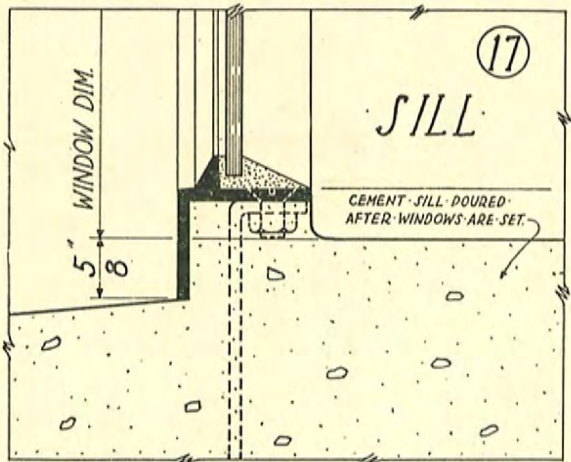
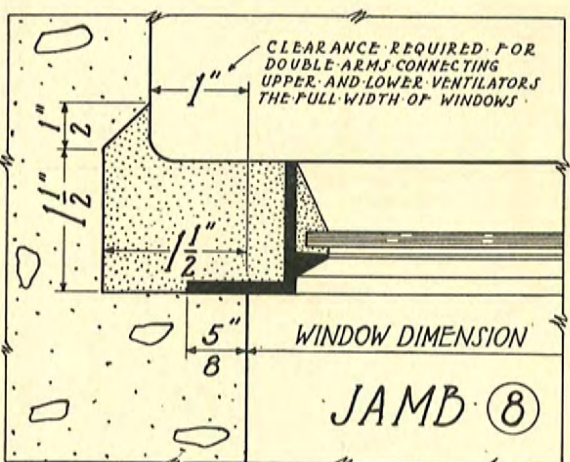
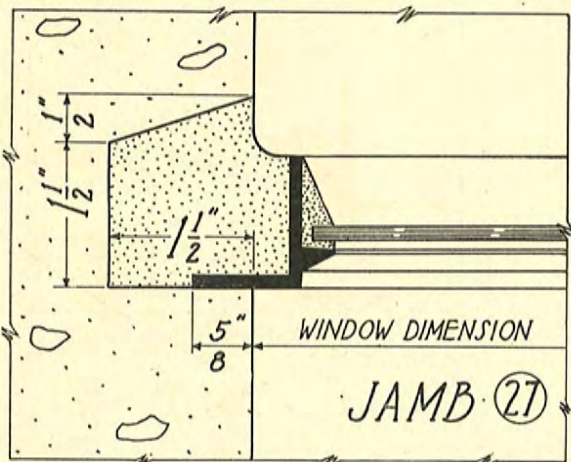
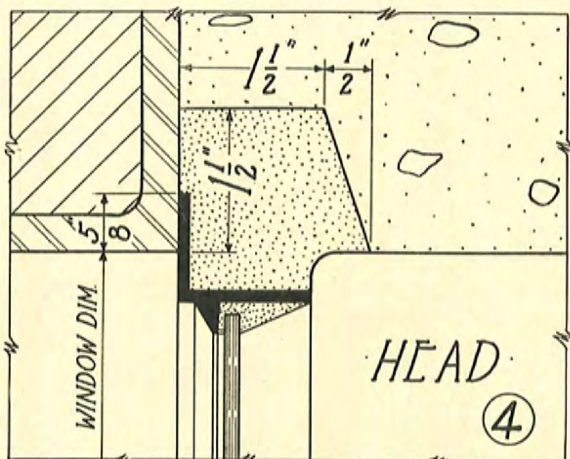
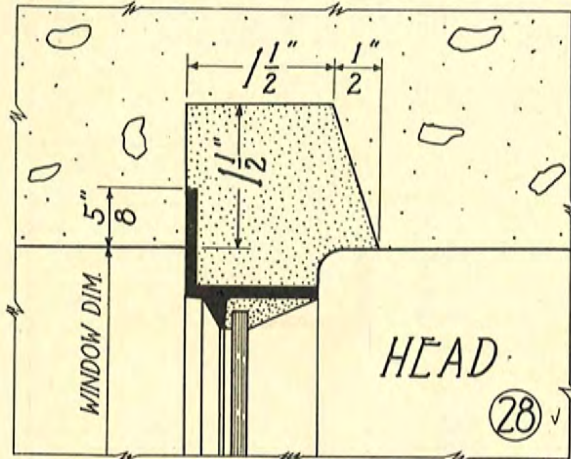

WALL DETAILS
STEEL

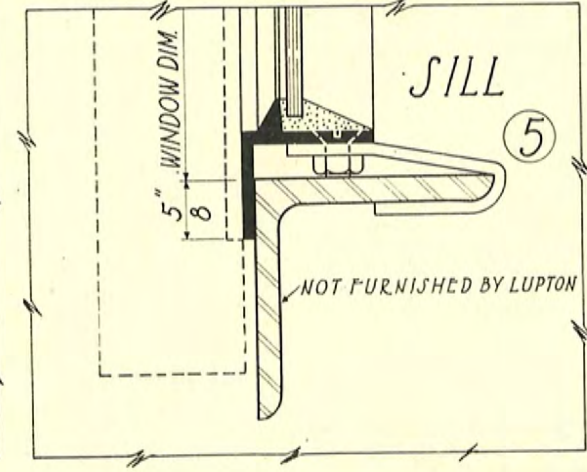
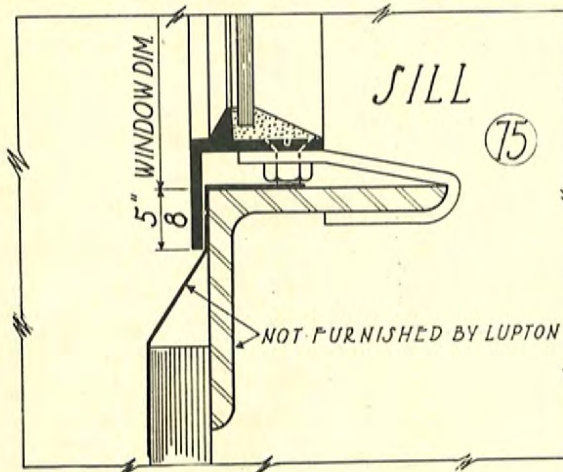
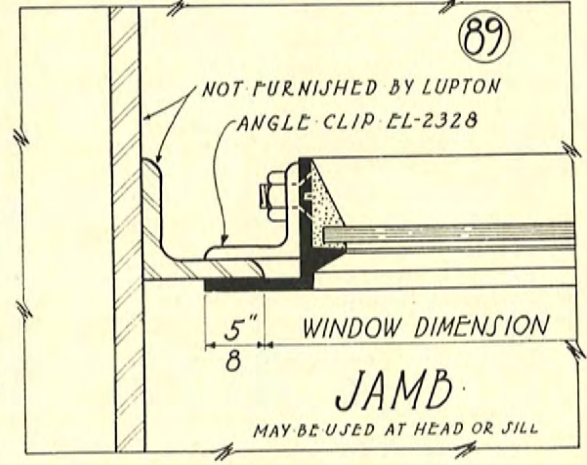
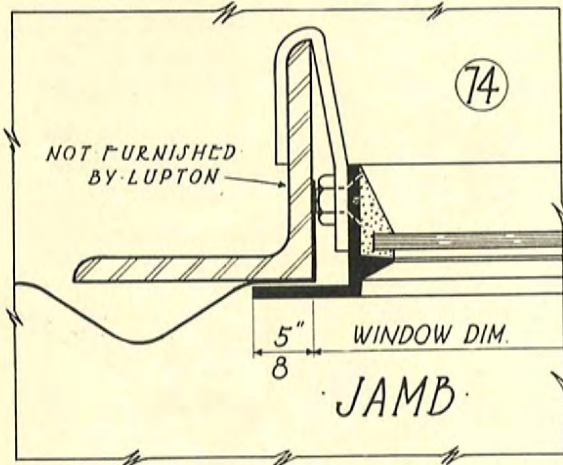
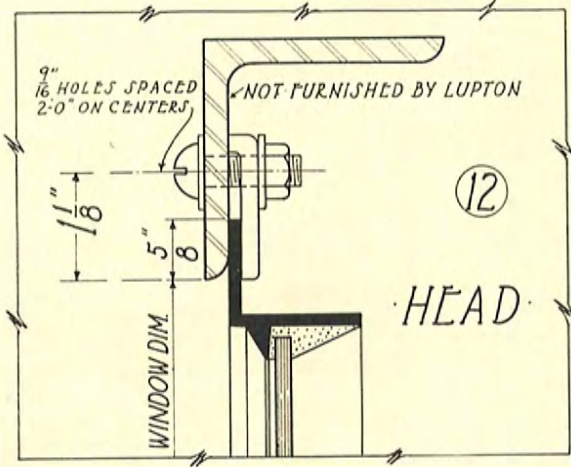
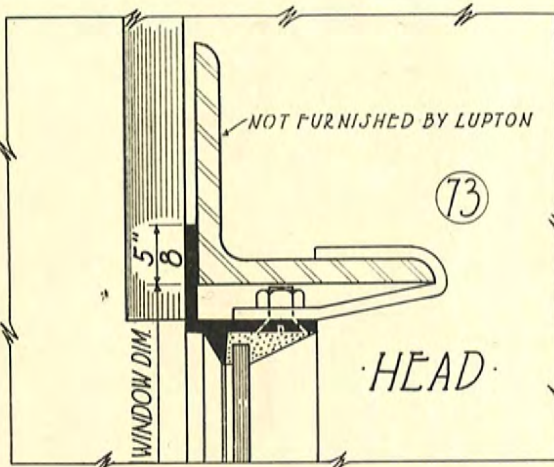

WALL DETAILS
STEEL

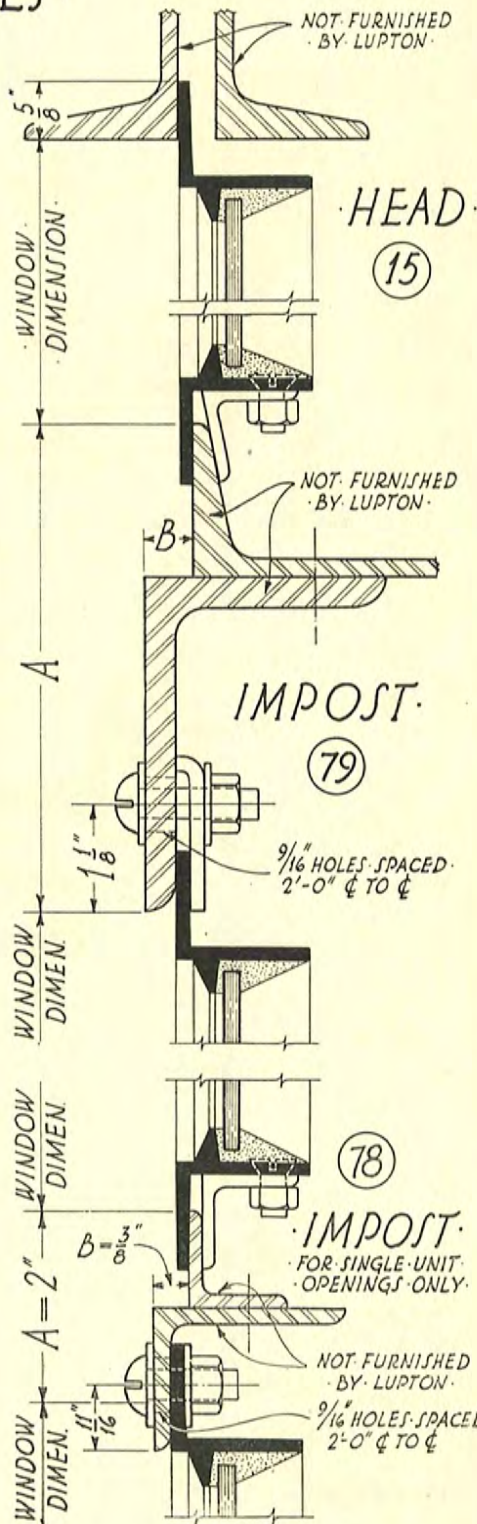
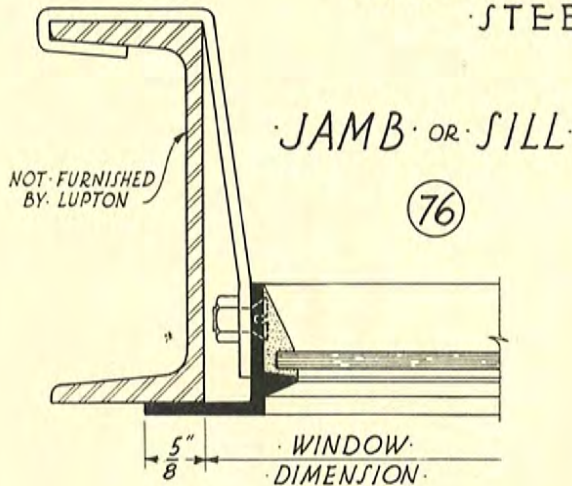

12" x 18" GLASS	DESIGN OF IMPOST	A DIM.	B DIM.	14" x 20" GLASS
No. OF LIGHTS WIDE				No. OF LIGHTS WIDE
USED FOR SINGLE UNIT OPENINGS ONLY				
3 TO 6	ONE ANGLE - 2" x 1 1/2" x 3/16" ONE ANGLE - 1" x 1" x 1/8"	2"	3/8"	3 TO 6
USED FOR BOTH SINGLE AND MULTIPLE UNIT OPENINGS				
3 TO 9	TWO ANGLES - 2 1/2" x 2 1/2" x 3/16"	5"	3/8"	3 TO 8
10 TO 13	TWO ANGLES - 2 1/2" x 2 1/2" x 3/16" ONE PLATE 6" x 1/4"	5 1/4"	3/8"	9 TO 11
	OR ONE 4" CHANNEL ONE ANGLE - 3 1/2" x 2 1/2" x 1/4"	5 1/4"	1/2"	
14 TO 18	TWO ANGLES - 3" x 3" x 5/16" ONE PLATE 6" x 1/4"	6 1/8"	1/2"	12 TO 16
	OR ONE 6" CHANNEL ONE ANGLE - 4" x 3" x 5/16"	6 1/8"	1/2"	

DEAD LOAD OF WINDOW AND IMPOST TO BE SUPPORTED BY TIE RODS HUNG FROM BUILDING LINTELS AND ATTACHED TO IMPOSTS AT MULLION POINTS - TIE RODS NOT FURNISHED BY LUPTON.

·WALL·DETAILS·

TERRA·COTTA

·WOOD·

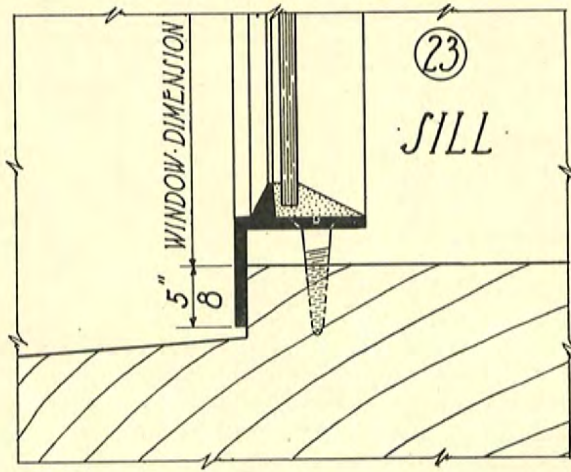
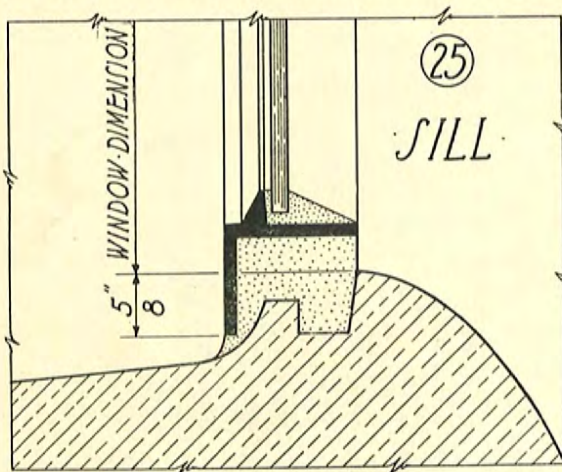
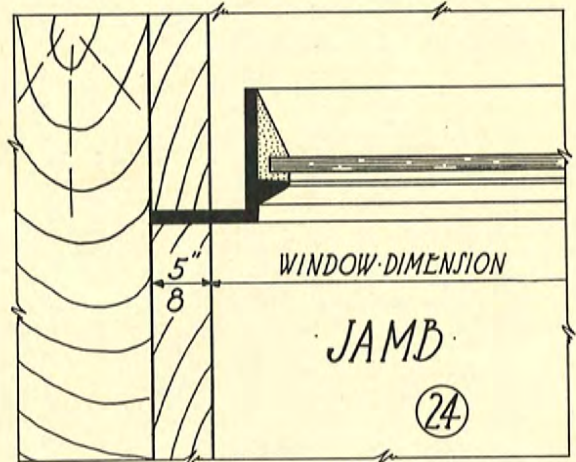
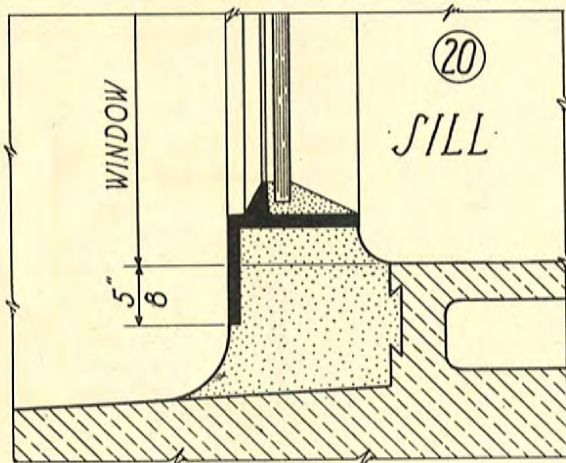
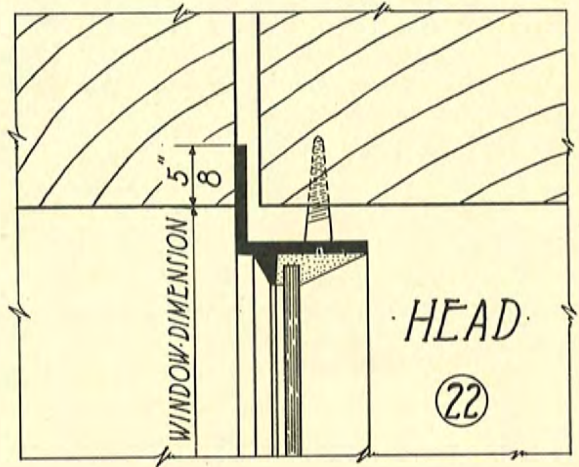
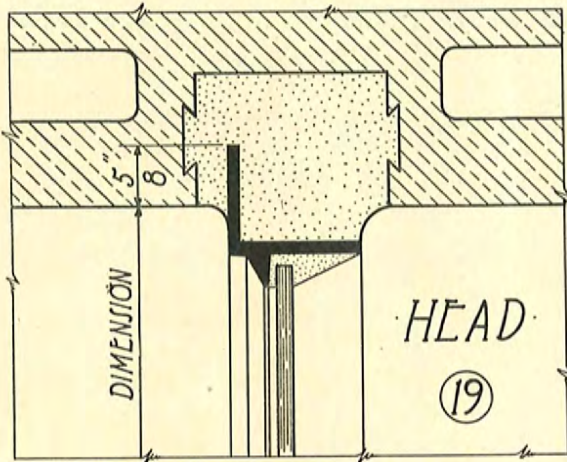

Wall Opening Measuring Points and Mullion Details

Wall opening dimensions are identical with the nominal dimensions of Lupton Steel Windows. For multiple window openings 2 inches are added to the width for each mullion.

This relation of window to opening is shown in the perspective drawing on this page which shows also the outside and inside positions of mullions.

Mullion flanges are placed outside of windows. See table opposite for limit heights of mullions.

When windows are set on sills of steel angles or channels, the stems of mullions must always project outside.

Drawings below show end cuts of standard mullions. Upper ends stop flush with lintels. Lower ends enter brick, concrete, wood and tile sills to a depth of $1\frac{3}{8}$ inches. (2 inches from measuring point.)

Limit Heights of T-Bar Mullions

Section 121

Stem Projecting *Inside*:

Use up to 5 lights wide, 7 ft. 0 in. high
or 6 " " " 5 ft. 6 in. "

Stem Projecting *Outside*:

Use up to 5 lights wide, 9 ft. 0 in. high
or 6 " " " 7 ft. 0 in. "

Section 339

Stem Projecting *Inside*:

Use up to 6 lights wide, 9 ft. high

Stem Projecting *Outside*:

Use up to 5 lights wide, 12 ft. 0 in. high
or 6 " " " 10 ft. 6 in. "

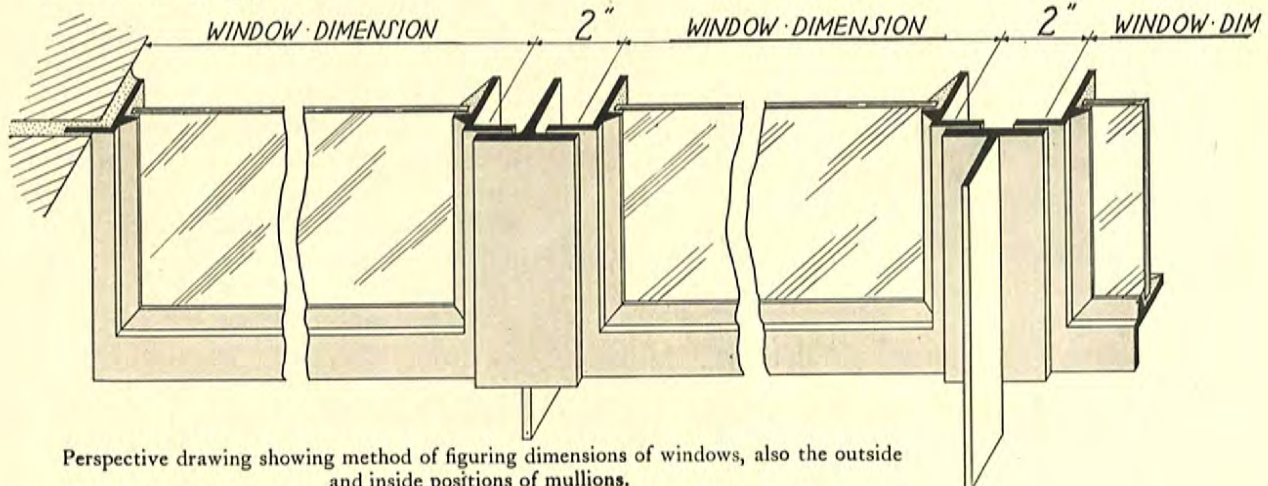

Perspective drawing showing method of figuring dimensions of windows, also the outside and inside positions of mullions.

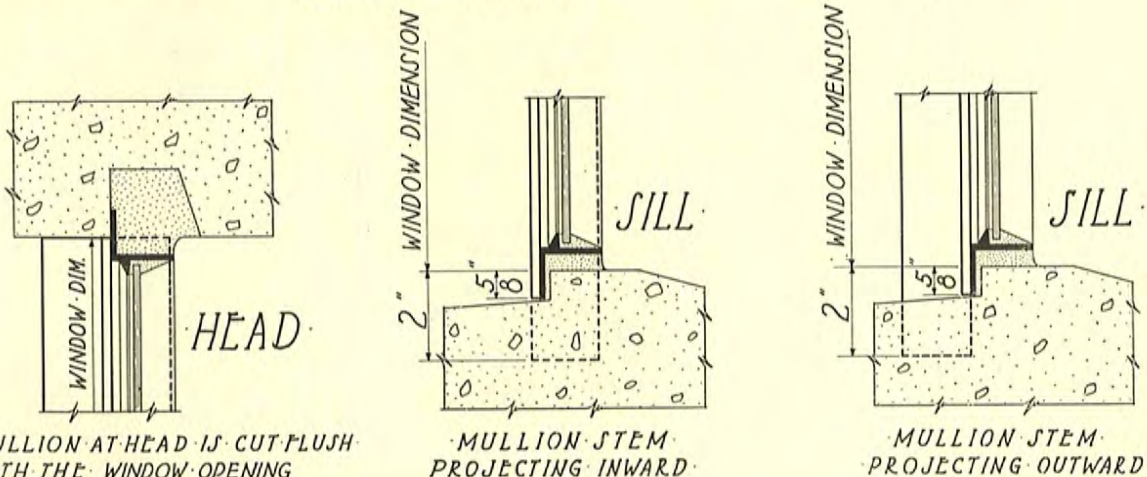

MULLION AT HEAD IS CUT FLUSH WITH THE WINDOW OPENING

MULLION STEM PROJECTING INWARD

MULLION STEM PROJECTING OUTWARD

Information Required with the Order

Early or immediate shipment of Lupton Pivoted Windows is frequently required. Such orders can be filled immediately from dealer stock *provided the customer furnishes complete information*. It occasionally happens that a rush order is held up for several days because the customer has forgotten to give us full information.

It is essential that the following points be clearly and completely covered. Before you send your order the quantities should be checked to see that they are correct and the description compared with the list below:

1. SHIPPING DATE desired (on non-stock sizes time must be allowed for assembling).
2. GLASS SIZES. (All Standard Windows including Dealer Stock are 12 x 18 in. and 14 x 20 in. glass sizes only.)
3. SIZES OF WINDOWS, in number of lights wide and high. Always specify width (in number of lights) first. Use symbols suggested on page 9.
4. NUMBER OF VENTILATORS IN EACH WINDOW, also their size and location. Use symbols.
5. NUMBER OF WINDOW UNITS IN EACH OPENING. This tells us how many mullions are required.
6. SIZE OF OPENINGS, as a check on glass and window sizes. See table, page 19.
7. HEIGHT OF SILLS FROM FLOOR. This gives us the proper length of chains when chains are required, and tells us whether the lower ventilator should be operated by Chain or Stay Bar.

Where sill height is not specified, we supply Lupton Stay Bars with all single ventilators, also with the lower ventilators of pairs. Spring Catches and Chains are furnished with upper ventilators of pairs. Where sill height is specified we furnish Spring Catch and Chain operation only for ventilators whose bottom edges are more than 6 ft. above the floor. If for any reason Stay Bars are wanted on high windows or Chains on low windows, that fact must be noted in the order. See illustrations, page 6.
8. KIND OF WALL FASTENINGS REQUIRED. This depends on the construction of the walls—whether brick, concrete or steel; also on the method of attaching windows. It is necessary to give attachments in detail. To do this refer to pages 12 to 16 inclusive, and specify by the numbers in circles the details at head, jambs and sill which will be used.

Lupton Special Pivoted Windows

All windows which depart in any particular from the foregoing specifications of Lupton Standard and Dealer Stock Windows are classed as Special, require more time for delivery and cost more. Windows which have the same number and size of lights, but which have some requirement not included in the Standard and Dealer Stock Windows are classed as Special. For example, the use of frame members other than Section 308; different size or location of ventilators; different location of ventilator hinges.

Underwriters' Windows in standard sizes are not classed as Special.

We will furnish, at an extra charge, double connecting arms for the simultaneous control

of two ventilators in a window unit. These arms attach to adjustable brackets so that the ventilator is closed tight without slamming. If upper and lower ventilators for the full width of the units are connected by double arms, the jambs must have a reveal for clearance. See page 20.

It is recommended that ventilators not exceeding two lights in height be used. Single ventilators should not exceed 5 ft. in width or 3 ft. 6 in. in height.

To order Lupton Special Pivoted Windows, the same system of symbols is to be used as for Standard and Dealer Stock Windows. Glass size must be specifically stated.

Wall Opening Sizes

Standard and Dealer Stock Sizes

All frame members are assumed to have a 5/8 inch bearing at head, jambs and sill. Opening sizes and nominal window sizes are taken from these bearing points and are therefore identical, being 5/8 inch on each edge smaller than the overall dimensions of the window. Wherever window sizes are given, nominal or opening sizes are meant. The table opposite shows symmetrical combinations of standard units with resulting wall openings.

Special Sizes

Window sizes for Special Glass using angle frame member Section 308, are figured as follows:

For single units, add 3/8 in. to width or height of each light. Multiply by the number of lights and add 7/8 inch.

For width of multiple units, add together the width as above of the various units in an opening, and add 2 inches to the width for each mullion. (Use glass sizes as for stationary lights when figuring opening sizes.)

Glass Sizes

Lights in stationary sections of Standard Window and Dealer Stock units are the full 12 x 18 in. or 14 x 20 in. size.

The outside lights of all ventilators are reduced 1 in. in width or height, or both, to allow for the space taken by the weathering around the ventilators. See diagram below.

14	14	14	14	14
20	20	20	20	20
14	13	14	13	14
20	19	19	19	20
14	13	14	13	14
20	19	19	19	20
14	14	14	14	14
20	20	20	20	20

Diagram above is typical of a unit using 14 in. x 20 in. Glass. The glass sizes of ventilators, whether standard or special, are reduced in the same manner, 1 inch in height or width or both.

A handy celluloid slide scale for figuring heights and widths of window openings will be sent free on request.

Combinations of Standard Sizes Width of Openings

Total Number of Lights in Width of Opening	12" x 18" Glass		ARRANGEMENT OF UNITS	Total Number of Mullions	14" x 20" Glass	
	WIDTHS OF OPENINGS				WIDTHS OF OPENINGS	
2	2'	1 5/8"	2	None	2'	5 5/8"
3	3'	2"	3	"	3'	8"
4	4'	2 3/8"	4	"	4'	10 3/8"
5	5'	2 3/4"	5	"	5'	12 3/4"
6	6'	3 1/8"	6	"	6'	15 1/8"
6	6'	6"	3, 3	1	7'	6"
8	8'	6 3/4"	4, 4	1	9'	10 3/4"
9	9'	10"	3, 3, 3	2	11'	4"
10	10'	7 1/2"	5, 5	1	12'	3 1/2"
10	10'	10 3/4"	3, 4, 3	2	12'	6 3/8"
11	11'	10 3/4"	3, 5, 3	2	13'	8 3/4"
11	11'	10 3/4"	4, 3, 4	2	13'	8 3/4"
12	12'	8 1/4"	6, 6	1	14'	8 1/4"
12	12'	11 1/8"	4, 4, 4	3	14'	11 1/8"
13	13'	11 1/2"	4, 5, 4	2	16'	1 1/2"
13	13'	11 1/2"	5, 3, 5	2	16'	1 1/2"
14	14'	11 1/8"	4, 6, 4	2	17'	3 1/2"
14	14'	11 7/8"	5, 4, 5	2	17'	3 7/8"
14	15'	2 3/4"	3, 4, 4, 3	3	17'	6 3/4"
15	16'	0 1/4"	5, 5, 5	2	18'	6 1/4"
15	16'	0 1/4"	6, 3, 6	2	18'	6 1/4"
16	17'	0 5/8"	5, 6, 5	2	19'	8 5/8"
16	17'	0 5/8"	6, 4, 6	2	19'	8 5/8"
16	17'	3 1/2"	4, 4, 4, 4	3	19'	11 1/2"
17	18'	1"	6, 5, 6	2	20'	11"
18	19'	1 3/8"	6, 6, 6	2	22'	1 3/8"
18	19'	4 1/4"	3, 6, 6, 3	3	22'	4 1/4"
18	19'	4 1/4"	4, 5, 5, 4	3	22'	4 1/4"
19	20'	7 1/2"	5, 3, 3, 3, 5	4	23'	9 1/2"
20	21'	5"	5, 5, 5, 5	3	24'	9"
20	21'	5"	4, 6, 6, 4	3	24'	9"
20	21'	7 7/8"	4, 4, 4, 4, 4	4	24'	11 7/8"
21	22'	8 1/4"	4, 4, 5, 4, 4	4	26'	2 1/4"
21	22'	8 1/4"	3, 5, 5, 5, 3	4	26'	2 1/4"
22	23'	5 3/4"	5, 6, 6, 5	3	27'	1 3/4"
22	23'	8 5/8"	5, 4, 4, 4, 5	4	27'	4 5/8"
22	23'	11 1/2"	3, 4, 4, 4, 4, 3	5	27'	7 1/2"
23	24'	9"	4, 5, 5, 5, 4	4	28'	7"
24	25'	6 1/2"	6, 6, 6, 6	3	29'	6 1/2"
24	25'	9 3/4"	3, 6, 6, 6, 3	4	29'	9 3/4"
24	26'	0 1/4"	4, 4, 4, 4, 4, 4	5	30'	0 1/4"
25	26'	9 3/4"	5, 5, 5, 5, 5	4	30'	11 3/4"
26	27'	10 1/8"	5, 5, 6, 6, 5	4	32'	2 1/8"
26	28'	1"	5, 4, 4, 4, 4, 5	5	32'	5"
26	28'	1"	3, 5, 5, 5, 5, 3	5	32'	5"
27	28'	10 1/2"	6, 5, 5, 5, 6	4	33'	4 1/2"
28	29'	10 7/8"	5, 6, 6, 6, 5	4	34'	6 7/8"
28	30'	1 3/4"	4, 5, 5, 5, 5, 4	5	34'	9 3/4"
29	30'	11 1/4"	6, 6, 5, 6, 6	4	35'	9 1/4"
30	31'	11 5/8"	6, 6, 6, 6, 6	4	36'	11 5/8"
30	32'	2 1/2"	5, 5, 5, 5, 5, 5	5	37'	2 1/2"
31	33'	5 3/4"	4, 4, 5, 5, 5, 4, 4	6	38'	7 3/4"
32	34'	3 1/4"	4, 6, 6, 6, 6, 4	5	39'	7 1/4"
33	35'	6 1/2"	4, 5, 5, 5, 5, 5, 4	6	41'	0 1/2"
34	36'	4"	5, 6, 6, 6, 6, 5	5	42'	0"
35	37'	7 1/4"	5, 5, 5, 5, 5, 5, 5	6	43'	5 1/4"
36	38'	4 3/4"	6, 6, 6, 6, 6, 6	5	44'	4 3/4"
37	39'	8"	6, 5, 5, 5, 5, 5, 6	6	45'	10"
38	40'	8 3/8"	4, 6, 6, 6, 6, 6, 4	6	47'	0 3/8"
39	41'	8 3/4"	6, 6, 6, 3, 6, 6, 6	6	48'	2 3/4"
40	42'	9 1/8"	6, 6, 6, 4, 6, 6, 6	6	49'	5 1/8"
40	43'	0"	5, 5, 5, 5, 5, 5, 5, 5	7	49'	8"
41	43'	9 1/2"	6, 6, 6, 5, 6, 6, 6	6	50'	7 1/2"
42	44'	9 7/8"	6, 6, 6, 6, 6, 6, 6	6	51'	9 7/8"
42	45'	0 3/4"	6, 5, 5, 5, 5, 5, 5, 6	7	52'	0 3/4"

Height of Openings

12" x 18" glass		14" x 20" glass	
Lights High	Height of Openings	Lights High	Height of Openings
1	1' 7 1/4"	1	1' 9 1/4"
2	3' 1 5/8"	2	3' 5 5/8"
3	4' 8"	3	5' 2"
4	6' 2 3/8"	4	6' 10 3/8"
5	7' 8 3/4"	5	8' 6 3/4"
6	9' 3 1/8"	6	10' 3 1/8"
7	10' 9 1/2"	7	11' 11 1/2"

Designing the Walls

Details on pages 12 to 16 inclusive show the commonly used methods of arranging wall openings to receive Lupton Standard or Dealer Stock Pivoted Windows. Opening sizes are identical with the nominal window sizes. Where several units occur in an opening, 2 inches are added for the width of each standard T-Bar mullion.

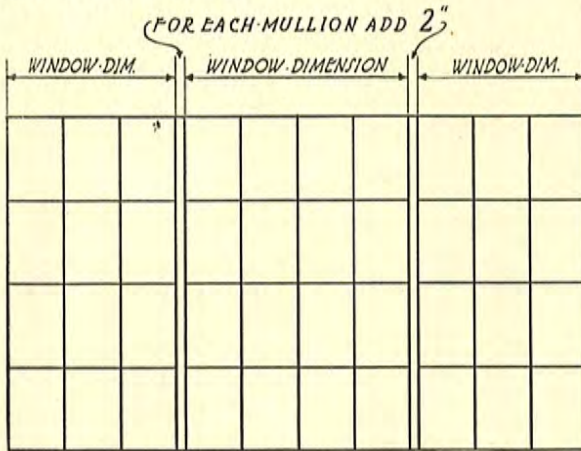

Lupton Standard Mullions do not attach to the head or lintel. Their stems extend in the brick or concrete sills 2 inches below the measuring lines of the windows. Recesses must be provided in the sills to receive the mullions if the sills are set before the windows are erected.

Mullions are always attached with the flanges of the T-Bars outside of the window

frame members. In brick and concrete walls, the stems may project either inside or outside, according to the size of units. (See page 17.) In steel framing the stem must always project outside. (See detail 5, page 14.)

Windows are secured by bolts, clips or grout. The frame members are punched at the sides for mullion bolts and at the sills for Wall Ties. Standard Clips and Wall Ties (see page 23) should be used where possible. No holes are provided in vertical leg of top frame member unless specified by customer.

If but one window is used in an opening in a brick or concrete wall, special provision is necessary to insert it. (See under "Building the Walls," page 21.)

With all kinds of steel windows it is essential that the structural steel lintels or other supporting members shall carry their load without deflecting upon the windows so that ventilators will not bind.

A special case arises in brick and concrete walls where windows have full width upper and lower ventilators connected by double arms. To give clearance for the arms in brick, the jambs must have a reveal (see lower left detail), or a special jamb plate (see lower right detail). For concrete, see center detail at bottom. Otherwise, it is necessary for the end units of windows to have stationary lights adjoining jambs.

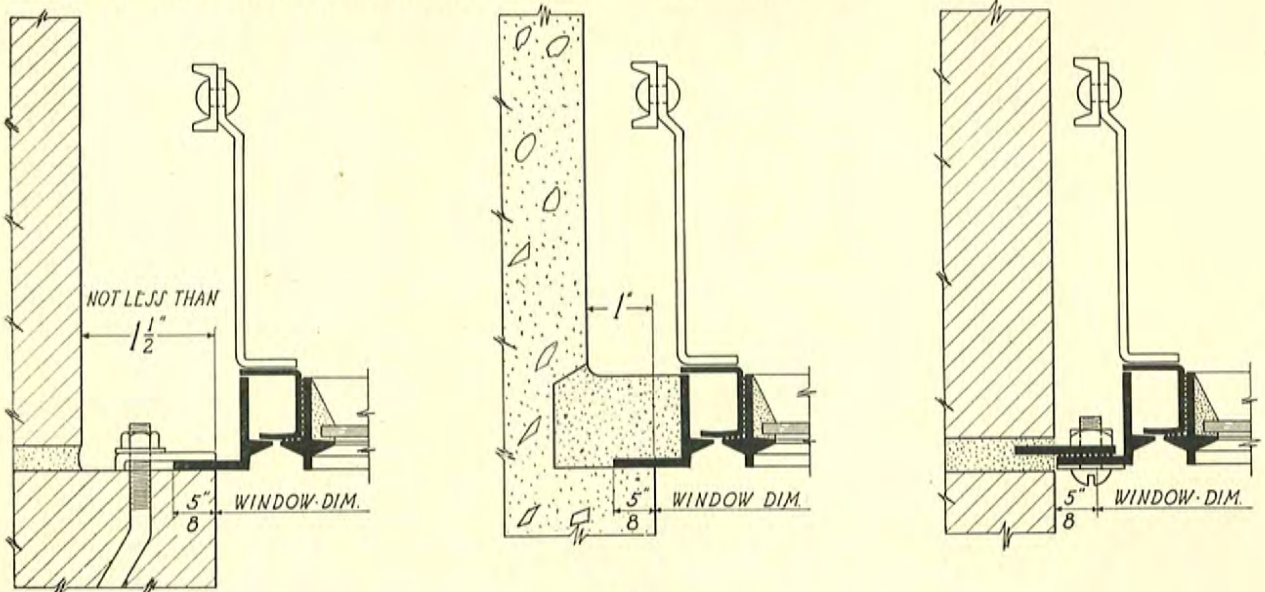

Building the Walls

Lupton Pivoted Windows are built to support glass and to withstand wind pressure after they are properly placed in the walls. They are not built to endure miscellaneous rough handling or to hold the bricks and lintels in place.

We recommend that the walls be built before windows are set

This applies to all types of construction except sometimes in brick walls where but one window unit per opening is used. See under "Brick Walls" below.

Brick Walls: Standard practice is shown in details on page 12. Brick sills and poured-in-place concrete sills should not be set until windows are erected. Jambs of multiple openings should have a vertical groove $\frac{3}{8}$ inch wide, $1\frac{1}{2}$ inches deep, raked out of mortar by the mason when laying the brick joint.

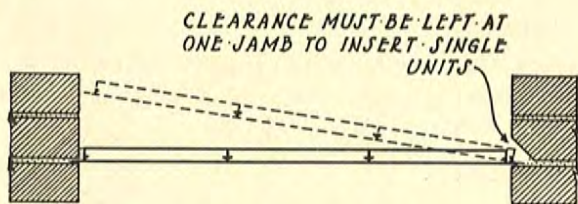

Openings taking but one window unit must have one jamb left unfinished until the windows are set. Alternative constructions are to make each jamb with a reveal (detail 70, page 12), or to chip the bricks in each jamb so that one side of the window can be inserted and the other side swung into place. (See detail 11, page 12.) If detail 11 is used, it is necessary to provide extra clearance at head or sill to avoid interference with the window when the latter is inserted.

Where pre-cast, terra cotta or cut stone sills are used, the lintel must allow window to clear sill before being placed in final position or sill must be made lower than usual practice, building the sill to the desired height with grout after windows are set. Mullion stems must enter recesses or joints in sill.

The lintels may be structural steel members with a continuous plate, angles, or $\frac{3}{8}$ inch groove for attaching windows. (See detail 9, page 12, and detail 12, page 14.)

Concrete Walls: Grooves not less than 2 inches wide, $1\frac{1}{2}$ inches deep, are moulded in jambs and lintel. (Page 13.)

Where but one window unit is used in an opening, grooves in the lintel and one jamb must be larger as required to insert the window or the jambs must be made with a reveal (detail 8, page 13).

Poured-in-place sills are recommended. If pre-cast or cut stone sills are used, the groove at head must be deep enough to allow window to be lifted clear of sill before being set. (See details below.)

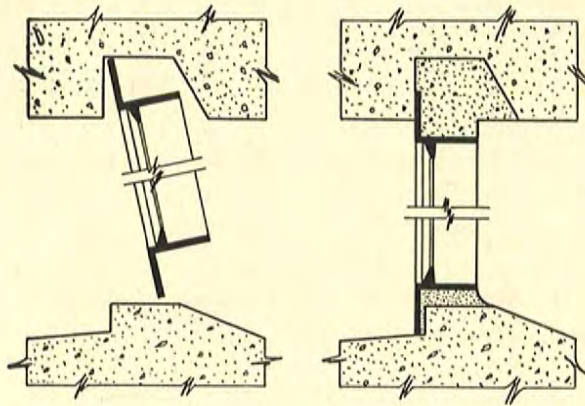

Steel Framing: Either of two treatments may be used at the head. The first is to attach to the lintel an angle member having a vertical inner face not less than $2\frac{1}{2}$ inches deep and to attach the window to it by Lupton Standard Clips No. EL-435. (See detail 12, page 14.) The second is to rivet two channels back to back with spreaders between them, making a $\frac{3}{8}$ inch space to receive the heads of the windows. (See detail 15, page 15.) For the jambs and sills, angles or channels are used with clips or straps to secure the windows. (See details on pages 14 and 15.) The T-Bar mullion is always placed outside the window, with stem projecting out.

Wood Walls: The standard Lupton angle frame member, Section 308, may be attached to wood walls in a great variety of ways. Typical details are given on page 16. *It is essential that the lintels shall carry their load without deflection against the window.*

Erecting and Glazing the Windows

Note: Hinges are ABOVE center of ventilators and are on the inner face of windows. Their position should be noted when placing windows. It should also be noted that putty is on inside of windows.

Brick Walls: The end window units in each opening are first set with the flanges of frame members Section 308 in the jamb grooves; then the remaining units and their mullions are set and loosely bolted; after which they are leveled and wedged against the jambs and head. The mullion bolts and the bolts or clips at the lintel are then tightened and the jamb grooves and sill are grouted by the brick mason. Mullions are set with flanges outside of windows, with stem turned in or out.

If sills are left unfinished until windows are in place, the windows must be supported on wood blocks or bricks, which are set under corners of windows only in order not to distort the windows.

The head and jambs should be grouted after the sill has been finished.

Single units in openings are treated according to the provision made to receive them. (See under "Building the Walls," page 21.)

Concrete Walls: Same general procedure as for brick walls. The grooves in concrete are grouted after windows are wedged. If there is but one unit per opening, it must be inserted in the larger jamb groove first.

Steel Framing: The windows are attached by bolts or clips as shown on pages 14 and 15. They are first loosely bolted and lined up by wedges, after which the bolts are tightened. The mullions must be set with the stems turned outside and the flanges outside the windows.

Wood Framing: Use same general procedure as for steel framing, except that screws

are used instead of clips. Groove is required for mullion stem whether turned out or in, unless clearance is provided below window.

After Erection: Wires holding ventilators shut are removed and Spring Catches or Stay Bars attached.

Glazing: Lupton Steel Windows are glazed after erection. The lights are held by the wire Glazing Clips No. 039, shown on page 23, four being furnished for each light. They are sprung by hand into holes in the muntins and frame, and their elasticity permits the glass to expand without breaking.

Glass should be carefully back-puttied, and putty should also be applied inside and beveled. Special putty for steel windows should be used, as ordinary putty dries out and breaks away.

When ordering glass it is important to note that border lights in ventilators are smaller than the other lights. See "Glass Sizes in Ventilators," page 19.

Painting: Windows are painted one coat at factory. They should receive at least two coats of paint after erection.

Operators: Where it is desired to operate several ventilators simultaneously, Lupton Operating Device is furnished. This device will not answer where unusually long lines of ventilators are to be operated simultaneously. For long lines, Pond Operating Device, either hand or motor operated, is recommended. Lupton Operating Device is described on pages 40 to 47 of this catalogue. Pond Operating Device is described in another catalogue.

LUPTON PIVOTED WINDOWS



Groove provided in concrete walls to receive flange of Lupton Pivoted Windows.

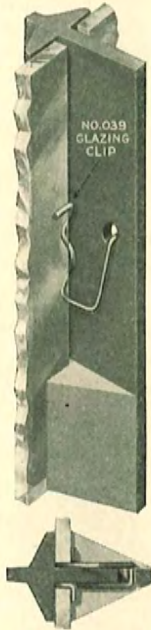

The Standard Lupton Glazing Clip, No. 039, with putty partly broken away.



Lupton Pivoted Windows in concrete walls. Windows are plumbed, wedged and then grouted.

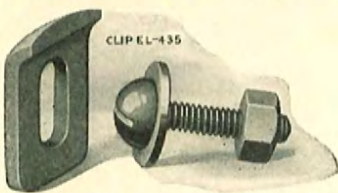

Standard Lupton Clip, No. EL-435 for attaching Section 308 to steel framing.



Standard Lupton Wall Tie, No. EL-1739, for anchoring Section 308 to concrete sills.

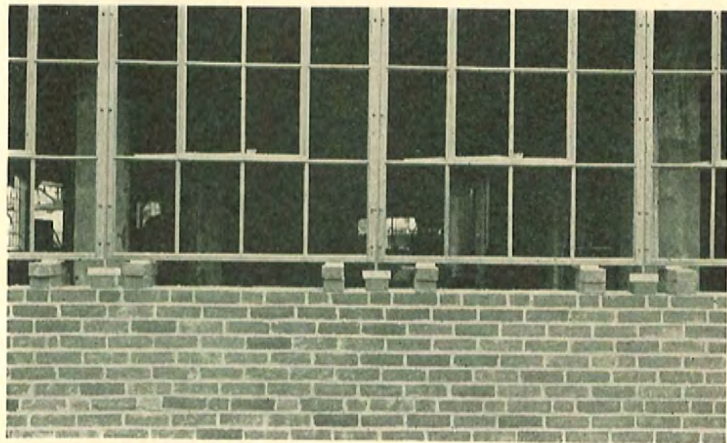

Showing method of supporting windows by blocks or bricks until wedged and bolted.

Specifications

Steel Windows

1. All windows throughout (except as otherwise noted on drawings) shall be Lupton Steel Pivoted Windows, made by David Lupton's Sons Company, Philadelphia.
2. Members shall be solid rolled steel sections of Lupton standard shape. Frame members shall be angle section No. 308 with standard punching for attachment to adjacent work. Muntins shall be section No. 300. Joints shall be flush. Vertical muntins shall interlock with horizontal muntins at the joints, so that reforming of bars is unnecessary to hold them in place. After cutting, no member shall be less than $\frac{7}{8}$ inch deep.
3. Ventilators shall be hung on heavy steel hinges, cut integral with the weathering and so applied as to preserve weathering contact.
4. Weathering of ventilators shall provide a 2-point contact, enclosing an air space all around ventilator. Weep holes shall be provided where needed to drain condensation outside the windows.
5. Ventilators, not otherwise indicated, shall be furnished with Stay Bars. The Stay Bar, when locked, shall draw the ventilator tightly shut. Ventilators so specified and shown on drawings shall have Spring Catches and Chain.
6. Mullions shall be T-Bars, Sections No. 121 and 339.
Note: See table "Limit Heights of T-Bar Mullions," page 17.
In steel framing the mullion stems must always be turned outside.
7. T-Bar mullions shall have slotted holes, with suitable bolts and washers for attaching windows.
8. Wire Glazing Clips shall be furnished, four to each light, of shape to be easily applied and to hold the glass securely.
9. Windows shall be given a shop coat of window manufacturer's standard paint, oven-dried.

Field Work

10. Windows shall be erected by (state by whom).
11. When erecting the windows, units next to jambs shall be inserted first. Where sills are unfinished, windows shall be blocked up at lower corners only. Mullions shall be set as window units are set, and loosely bolted to said units. Next, all units shall be carefully lined up and wedged at jambs and head. All clips shall then be bolted tight and (in brick and concrete walls) the head and jambs grouted.
12. Glazing shall be done by (state by whom).
Note: Where glazing is done under another contract, insert paragraph 12 under "Steel Windows," and paragraph 13 here.
13. Windows shall be glazed with (state kind and thickness of glass: single thick should not be used) and glass shall be thoroughly bedded

Specifications

(CONTINUED)

in special steel window putty. This bed or back putty must prevent any contact of the glass with steel members, and shall be struck off flush with steel members. Four glazing

clips shall be used with each light. Inside putty shall be even with the daylight line of the window members and shall be beveled neatly.

Window Openings

The architect will find the following specifications useful to insure correct preparation of the walls to receive windows. Such portions as are appropriate should be included in the steel and masonry specifications. The intended connection at head, jambs and sill should be shown in the working plans. See recommended details, pages 12 to 16.

All wall opening dimensions shown on plans are to follow the nominal dimensions of the windows, as shown in details, diagrams of unit sizes, and table of combination widths, page 19. Except as otherwise specified, walls are to be built before windows are set.

Opening dimensions: The dimensions conform to window manufacturer's standards, and are to be followed by the masonry contractor without deviation. Details for attachment of windows are likewise shown on plans and must be carefully followed.

Jambs: In openings for multiple units in brick walls, the masonry contractor shall leave a groove or open joint, $\frac{3}{8}$ inch wide and $1\frac{1}{2}$ inch deep in the first (or other as shown on drawings) joint from outer face of wall. (Detail 31, page 12.) This open joint shall be plumb and true and free from mortar and other obstruction. In concrete jambs, a similar groove, not less than 2 inches wide by $1\frac{1}{2}$ inches deep, shall be located to correspond with the groove in brick jambs (Detail 27, page 13). Where single units of windows are used in brick or tile walls, they may be set while walls are being built; or one jamb may be left unfinished until unit is inserted; reveals may be used with clip (by Lupton), and anchor bolts (by others: See Detail 70, page 12): or the corners of the inner

bricks at the grooves may be chipped to give clearance to insert the windows. (Detail 11, page 12.)

Lintels: In brick walls, a structural steel lintel shall be furnished by the steel contractor, this member to provide a bearing for the windows. (Detail 9, page 12.) If sill is to be pre-cast concrete, terra cotta, or cut stone, the lintel must permit windows to be raised to clear sill before being lowered in place on the sill. In concrete walls a groove is to be cast in lintel not less than 2 inches wide by $1\frac{1}{2}$ inches deep in line with grooves in jambs. (Detail 28, page 13.) Lintels must carry their load without deflecting on windows and have proper provision for receiving windows.

Sills: Pre-cast, terra cotta or cut stone sills shall be set before windows are installed and shall contain recesses not less than 2 inches deep to receive the lower ends of the mullion stems. (Detail, page 17.) Brick and poured sills shall be left unfinished until the windows have been erected. (Detail 14, page 12; detail 17, page 13.)

Grouting: In all masonry walls after windows have been set and leveled, the masonry contractor shall fill the spaces between the frame members and the jambs, sill and concrete lintel with cement grout neatly pointed.

Lupton Underwriters' Pivoted Windows



Important: Lupton Underwriters' Pivoted Windows are furnished only when specified in bid and mentioned in contract.

Wherever wire glass is used for fire protection it is advisable to specify Underwriters' Windows and have the Underwriters' Label. This insures that the full measure of safety intended is actually secured.

Lupton Dealer Stock and Standard Windows of prescribed sizes may be converted into Underwriters' Windows by the addition of glazing angles and the special hardware illustrated on page 27.

As all the members are standard, orders for Lupton Underwriters' Windows can be filled from bars in factory stock, subject only to the delay for adding the hardware and glazing angles. This is the most economical way to buy Underwriters' Windows. Such orders can usually be filled promptly after receipt of complete information.

Where immediate delivery is essential, Dealer Stock Windows can be altered at our Philadelphia, Cleveland and Chicago warehouses, at a slight extra cost, to receive the special glazing angles and hardware before shipment. *Windows cannot be altered to receive Underwriters' Label after shipment.*

Following are the Underwriters' Laboratories' specifications, in condensed form, so far as they apply to pivoted windows:

1. Single Window units cannot exceed 84 sq. ft. in area, with neither dimension exceeding 12 ft. When mullions are used, each window unit cannot exceed 7 ft. in width or 12 ft. in height.

2. The exposed glass area must not exceed 350 sq. in. in any light, measured from toe to toe of the glazing angles. (Standard sizes are less than this.) One-quarter inch wire glass is always required.
3. In addition to putty, the lights are held by steel glazing angles measuring $\frac{1}{2}$ by $\frac{3}{16}$ inch: the long leg bears against the glass. The angles are held by steel screws.
4. Not more than two ventilators may be used in any window unit.

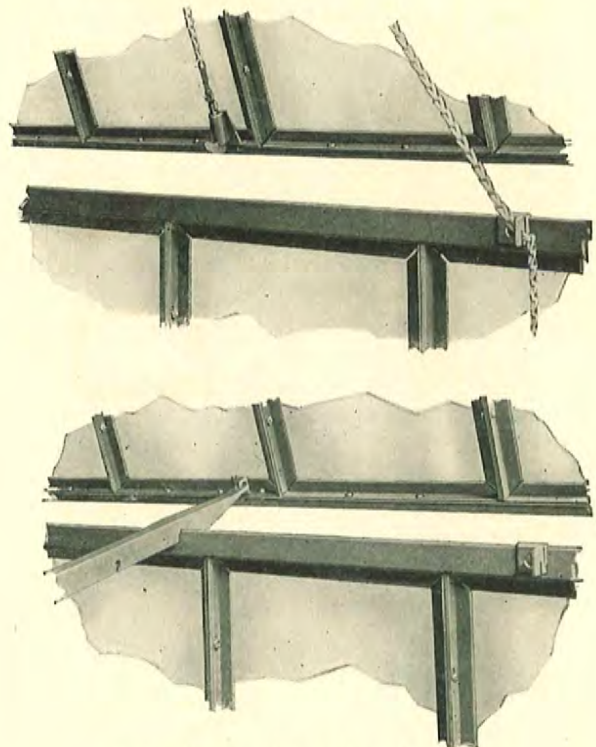

Spring Catch and Stay Bar. Former has fusible link in chain. Latter may be used instead of Catch and Chain, subject to approval of local inspection boards.

LUPTON PIVOTED WINDOWS

5. The Hinge is of standard Lupton design and construction.
6. Spring Catches are of standard Lupton construction. The Catch is at the bottom of the ventilator, so that its own weight tends to engage it if the Spring fails. The Chain passes over a standard roller at the top of the ventilator.
7. The Chain must contain a Fusible Link. When the Link fuses, the ventilator closes and locks automatically.
8. With the approval of the local inspection board, Stay Bars for manual operation may be used instead of Spring Catches and Fusible Links.
9. Mullions must be Lupton Section 339 and must be anchored at head or sill, either by projecting into the masonry, or by angle clips. Lupton Wall Ties No. EL-1739, or other wall ties not less than 4 in. long are required at brick and concrete sills.

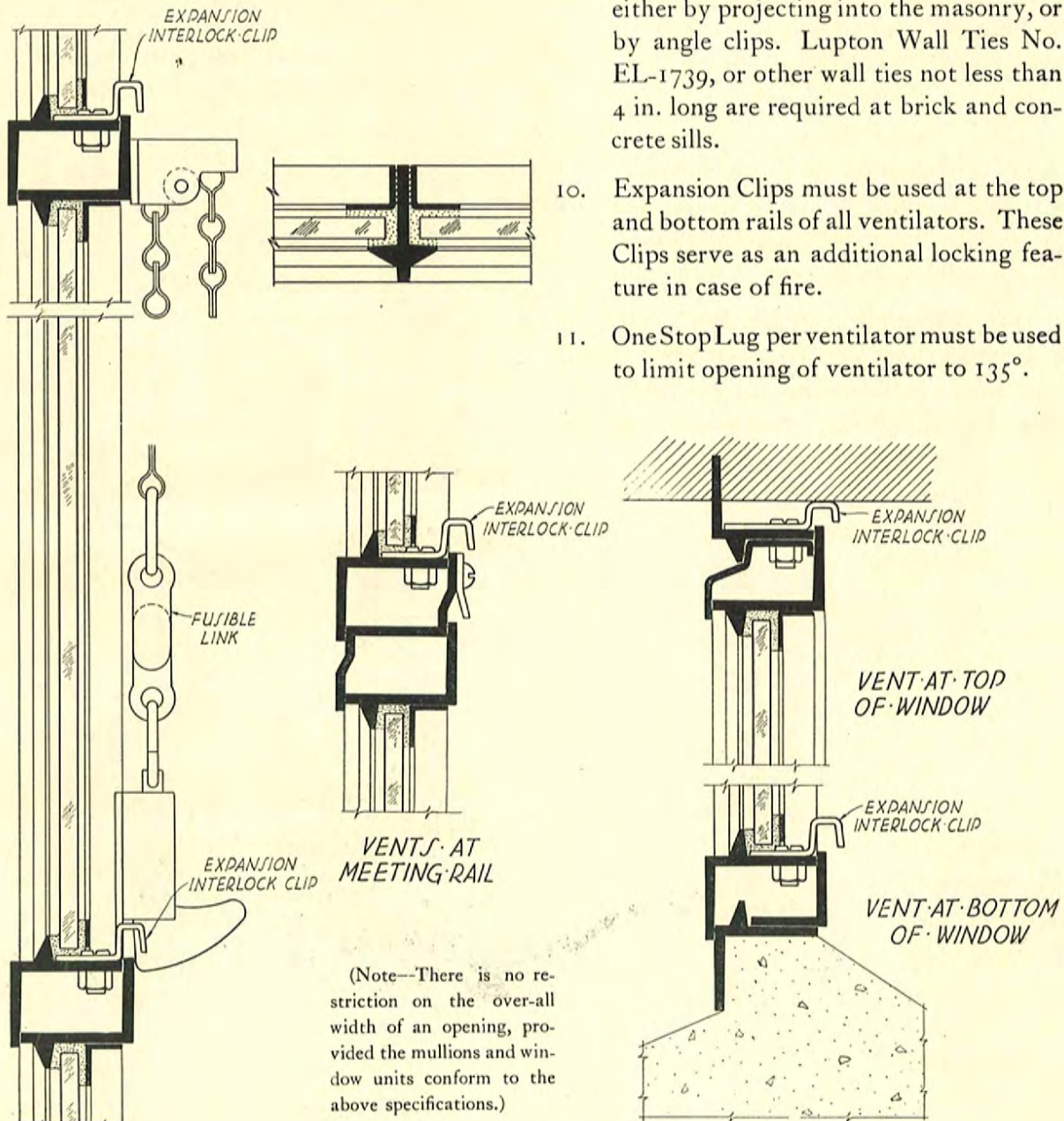

10. Expansion Clips must be used at the top and bottom rails of all ventilators. These Clips serve as an additional locking feature in case of fire.
11. One Stop Lug per ventilator must be used to limit opening of ventilator to 135°.

DAVID LUPTON'S SONS COMPANY

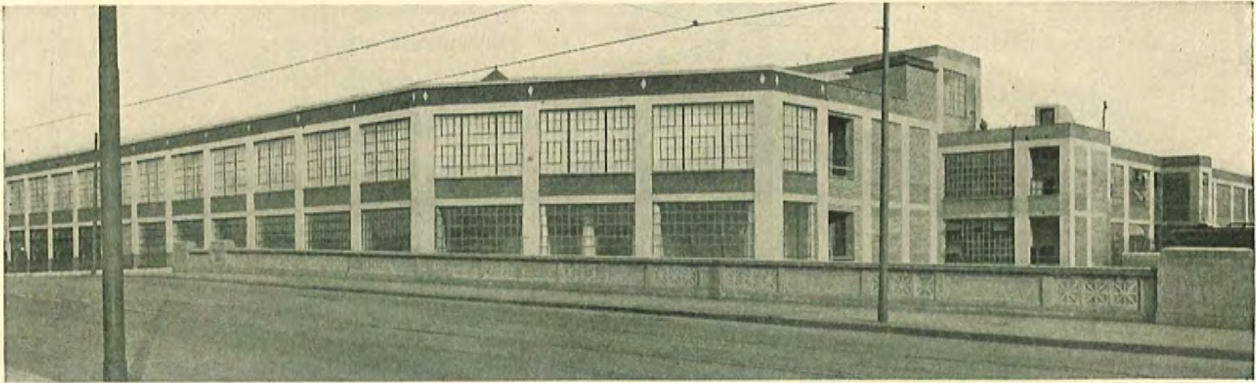

Brandle & Smith Company
Philadelphia

William Steele & Sons Company
Architects—Engineers—Contractors

This modern candy manufacturing plant uses Lupton Pivoted Windows throughout. Lupton Steel Partition and Steel Shelving, in addition, makes this building Lupton-equipped throughout.

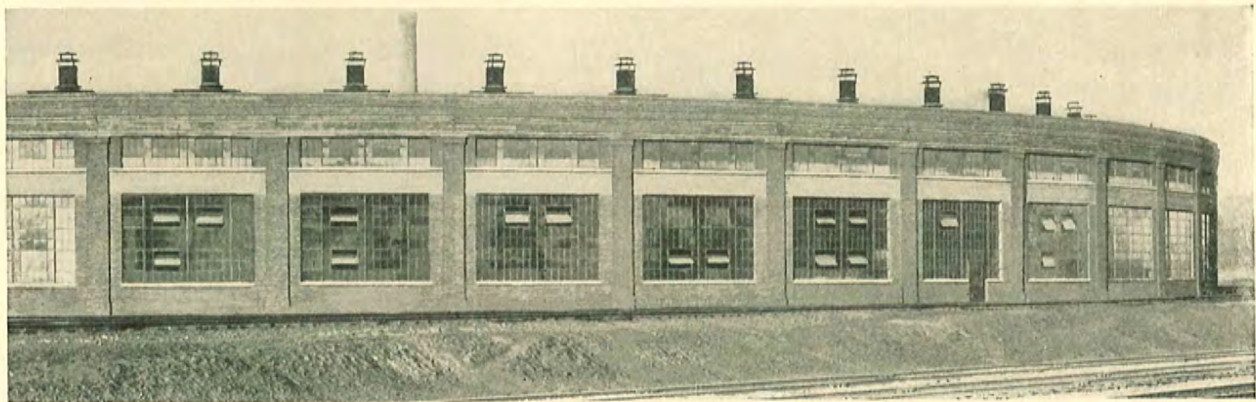

Washington Terminal Roundhouse
Washington, D. C.

The openings in this building were originally filled with wood windows, which deteriorated rapidly. Lupton Pivoted Windows were selected to replace the wood, only nominal alterations being necessary to make the change.



The Schwayder Trunk Company
Denver, Colo.

Austin Company
Architects and Builders

A one-story manufacturing plant with a second story in the office portion. The wide floor areas are well lighted and ventilated by Lupton Pivoted Windows, the ventilators operated by Lupton Stay Bars.

LUPTON PIVOTED WINDOWS

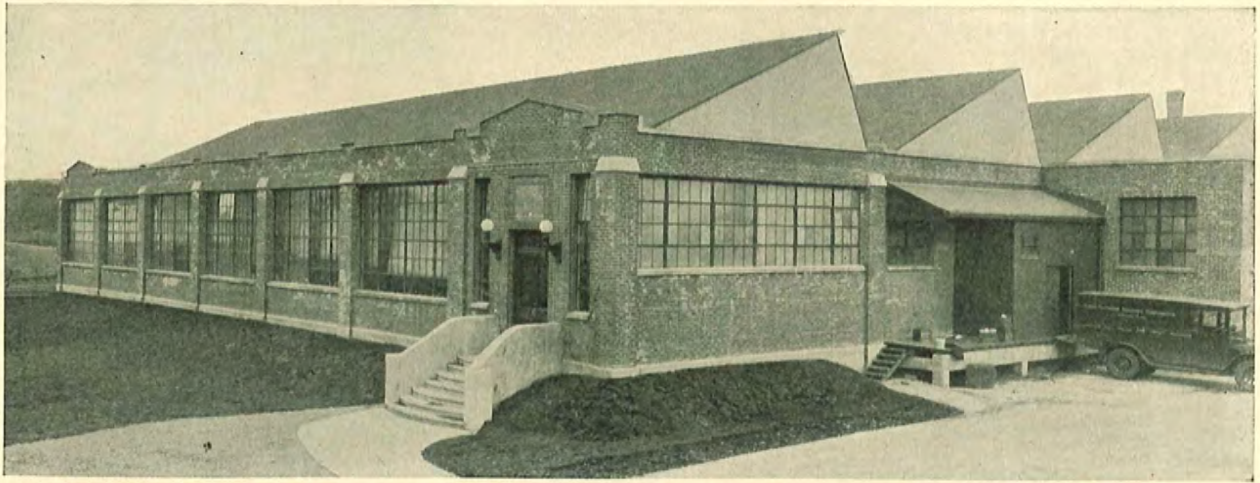

Norma Co. of America
Stamford, Conn.

Francisco & Jacobus, Architects
Post & McCord, Contractors

This building is used for hardening and light manufacturing. Besides the Lupton Pivoted Windows in the sidewalls, Pond Continuous Windows are used in the sawtooth roof.



McCormick & Company
Baltimore, Md.

M. A. Long Co.
Contractors and Engineers

A particularly satisfactory installation of Lupton Pivoted Windows is shown in this large Baltimore building. It is located opposite the water front, which subjects the windows to unusual weather conditions.

DAVID LUPTON'S SONS COMPANY

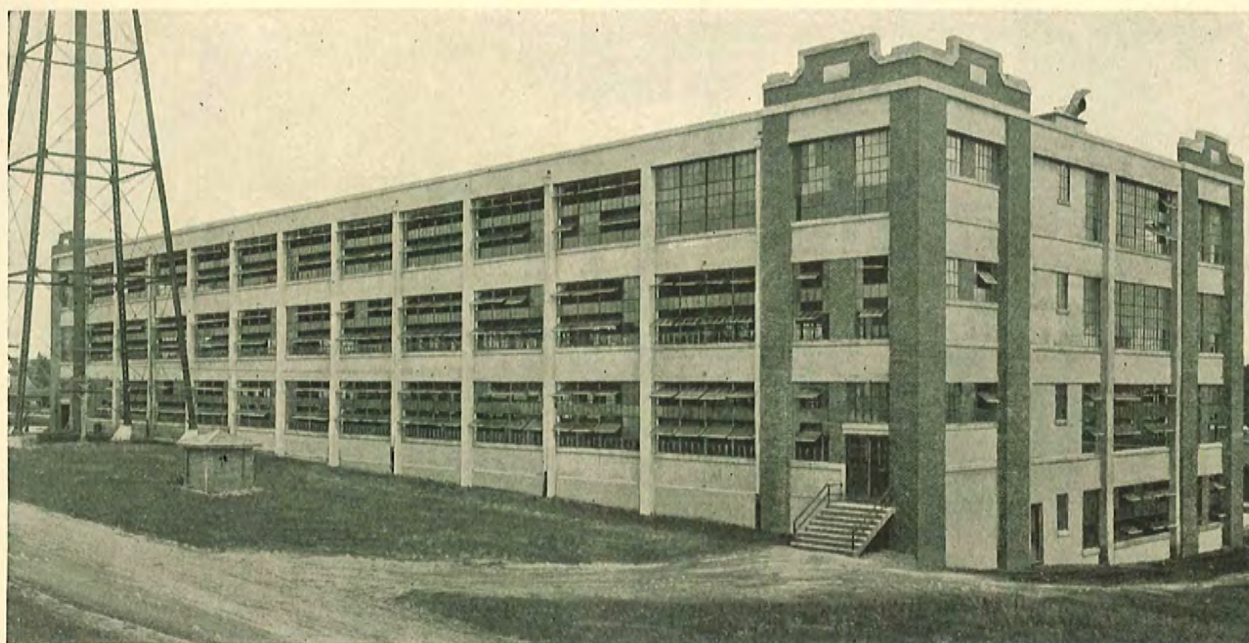

Musgrove Mills
Gaffney, S. C.

J. E. Surrine & Company, Architects
Potter & Shackelford, General Contractors

This modern multi-story textile mill is 288 feet long and 107 feet wide, and is equipped throughout with Lupton Pivoted Windows. The basement is used as a cloth room and machine shop, and the weaving and slashing is done on the first floor. The two upper floors serve for spinning, spooling, picking and carding. Lower view is of the interior, the upper ventilators controlled by Lupton Spring Catches and Chains.

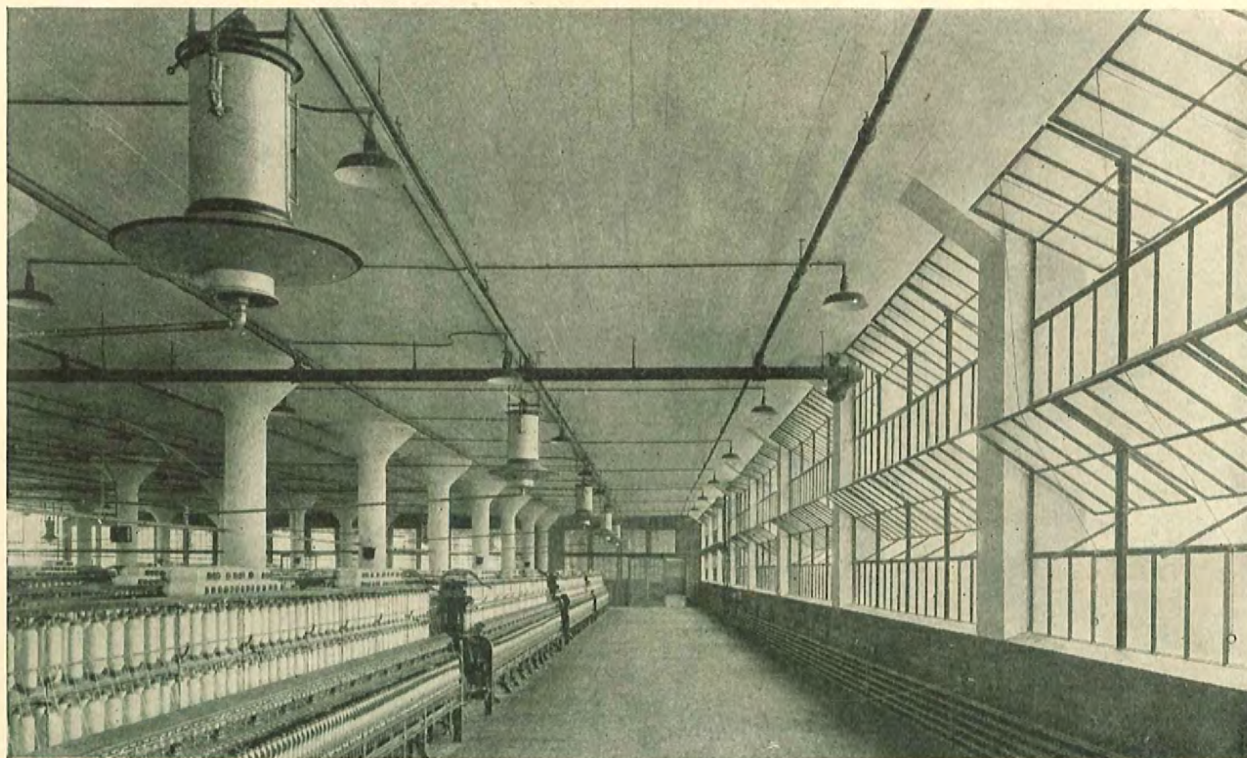

LUPTON PIVOTED WINDOWS

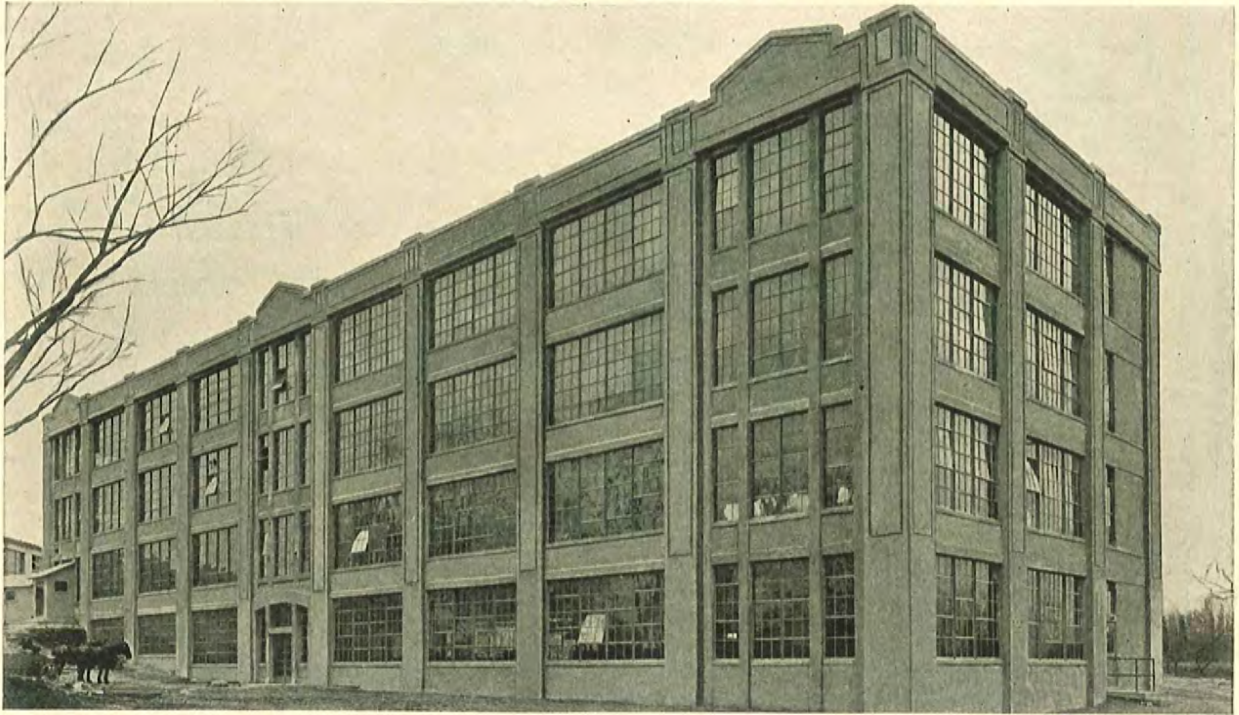

Conde Nast Publishing Co.
Stamford, Conn.

William Higginson, Architect
Turner Construction Co., Contractors

This building is used for the printing of several national magazines. Lupton Pivoted Windows in all side wall openings provide the daylight so necessary in a building used for this purpose.

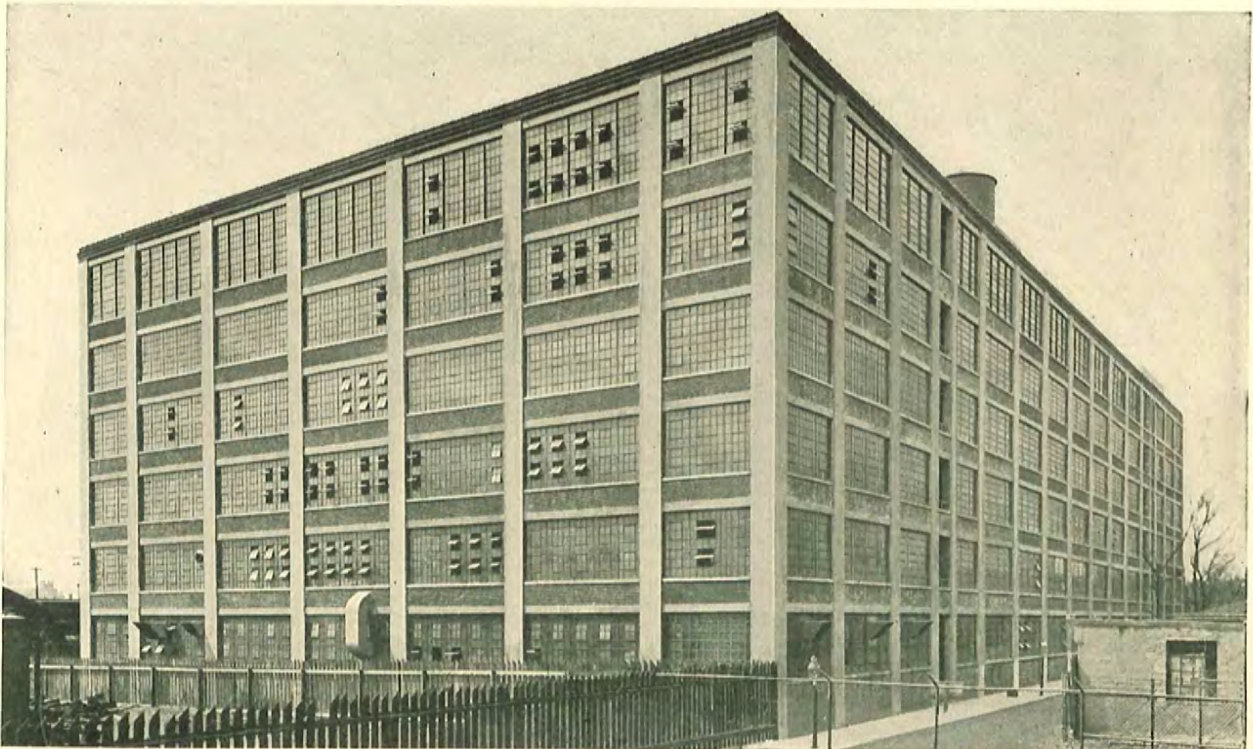

Collins and Aikman Co.
Philadelphia

Turner Construction Co.
Engineers and Contractors

A good example of the use of Lupton Pivoted Windows in a large multi-story manufacturing building. The upper and lower ventilators of a pair in each opening are operated simultaneously by Lupton Connecting Arms.

DAVID LUPTON'S SONS COMPANY

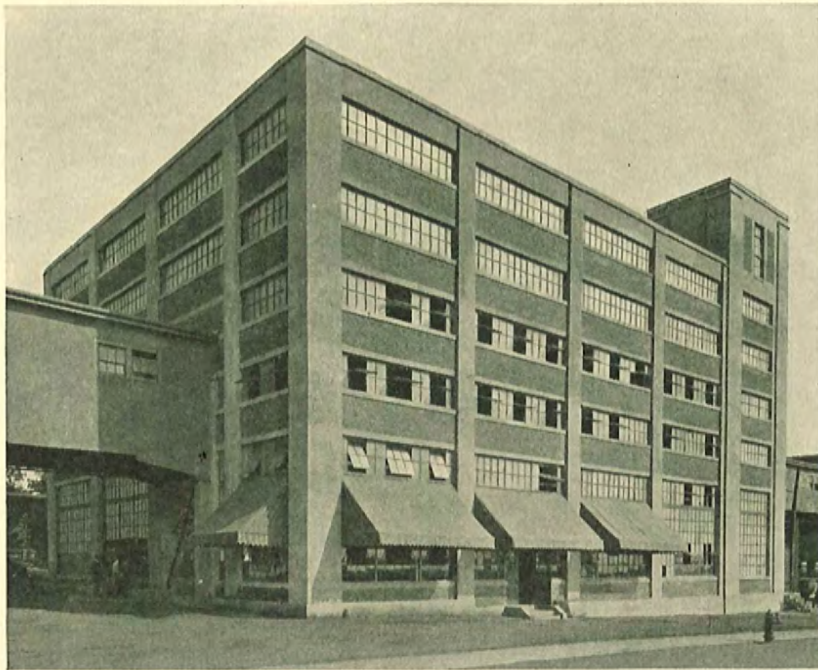

Pacific Mills, Lyman Division
Duncan, S. C.

Lockwood, Greene & Co.
Engineers

This building is one of a group in
Duncan, Lupton Pivoted Win-
dows being specified throughout.
The pleasing lines of this structure
are enhanced by the steel windows
in the sidewalls.



Baltimore & Ohio R. R. Grain Elevator
Baltimore, Md.

Metcalf & Co.
Architects

M. A. Long Co.
General Contractors

One of the largest grain elevators in the world. In keeping with the idea of permanency, Lupton Pivoted Windows were specified both for the main buildings and the bridges to the river piers. The latter do not show in this view.

LUPTON PIVOTED WINDOWS

Kohler Company
Boston, Mass.

Chase & Gilbert
Engineers

A modern warehouse building of concrete and steel. Lupton Pivoted Windows provide exceptional light over large floor areas. Ventilators in all openings are controlled by standard Lupton Stay Bars.

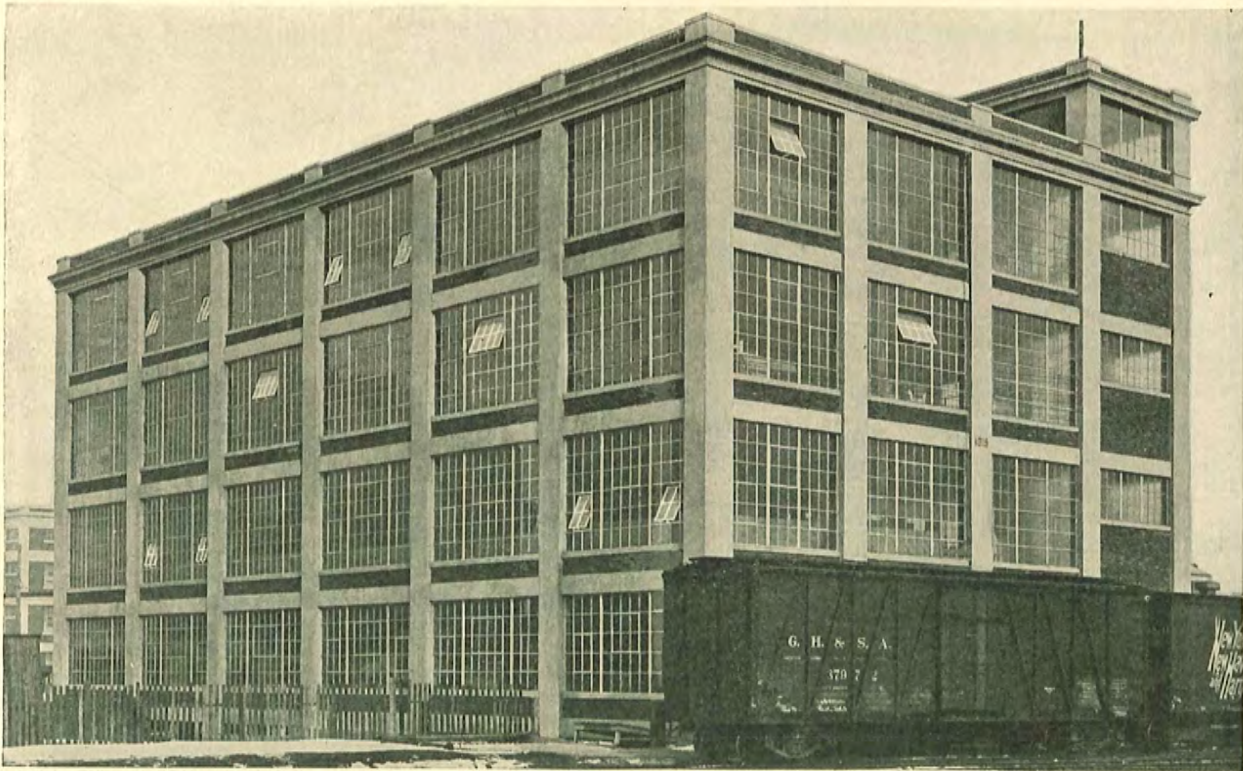

Beech-Nut Packing Company, Inc.
Rochester, N. Y.

Aberthaw Construction Co.
Contracting Engineers

Ample daylight and ventilation is afforded in this warehouse by large openings filled with Lupton Pivoted Windows.

DAVID LUPTON'S SONS COMPANY

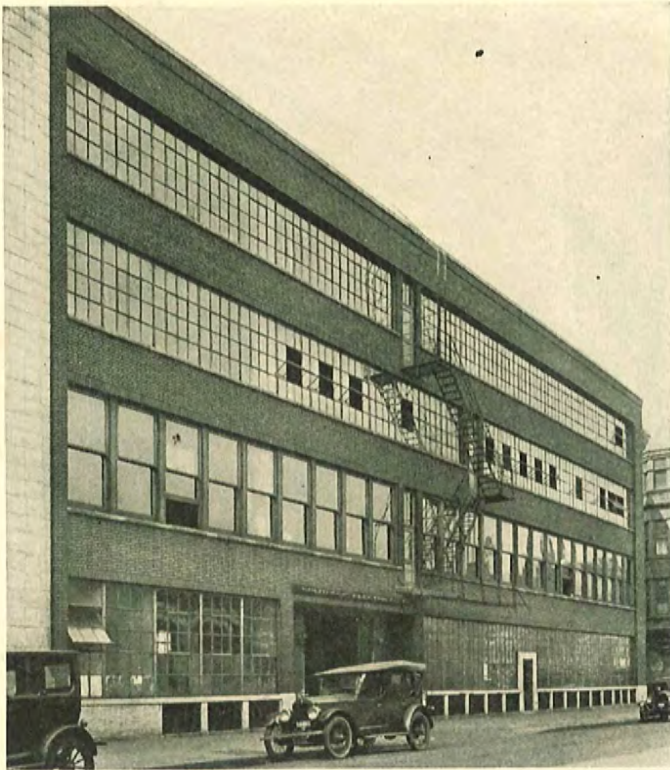

Splitdorf Building
Chicago, Ill.

Paul Gerhardt
Architect

A pleasing installation of Lupton Pivoted Windows and Double Hung Windows in a small manufacturing building. The Pivoted Windows are used on the first and two upper floors. The Double Hung plate windows were specified for the offices.

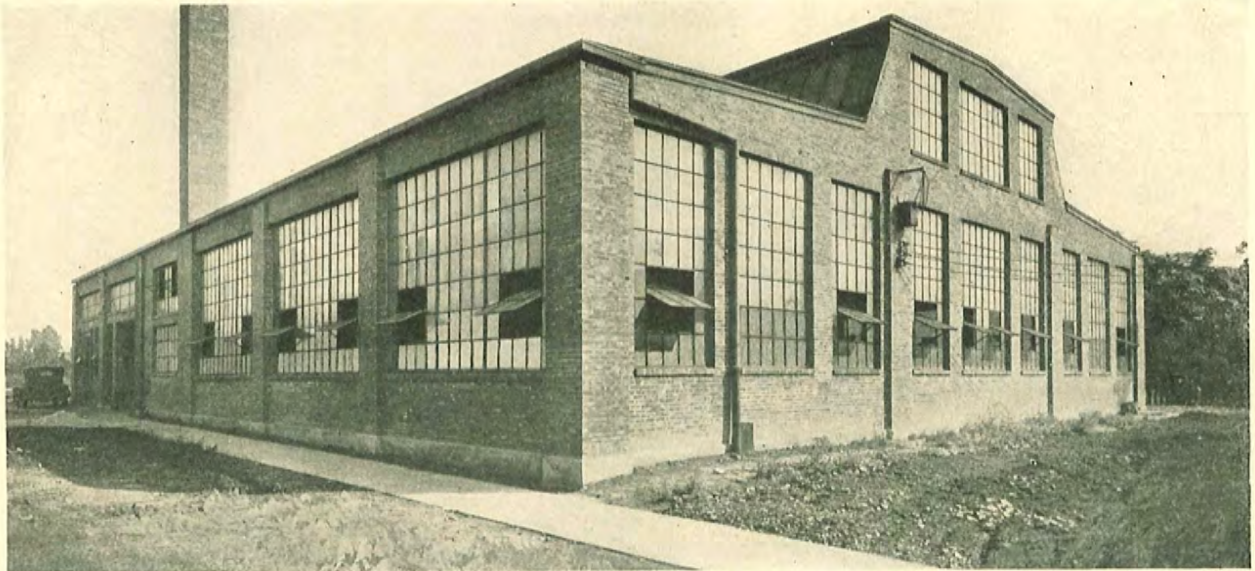

Carey Machine Company
Cleveland, Ohio

Ernest McGeorge, Engineer
Super-Built Construction Co.
Contractors

A small building which is exceptionally well lighted by the Lupton Pivoted Windows in the side walls. Pond Continuous Windows, controlled by Pond Operating Device, are used in the roof monitor.

LUPTON PIVOTED WINDOWS

Edward G. Budd Mfg. Company
Philadelphia

The Ballinger Company Wark Company
Architects Contractors

View shows front of large multi-story manufacturing building, equipped throughout with Lupton Pivoted Windows. The wide floor areas are abundantly lighted and ventilated by the large openings filled with Lupton Pivoted Windows.

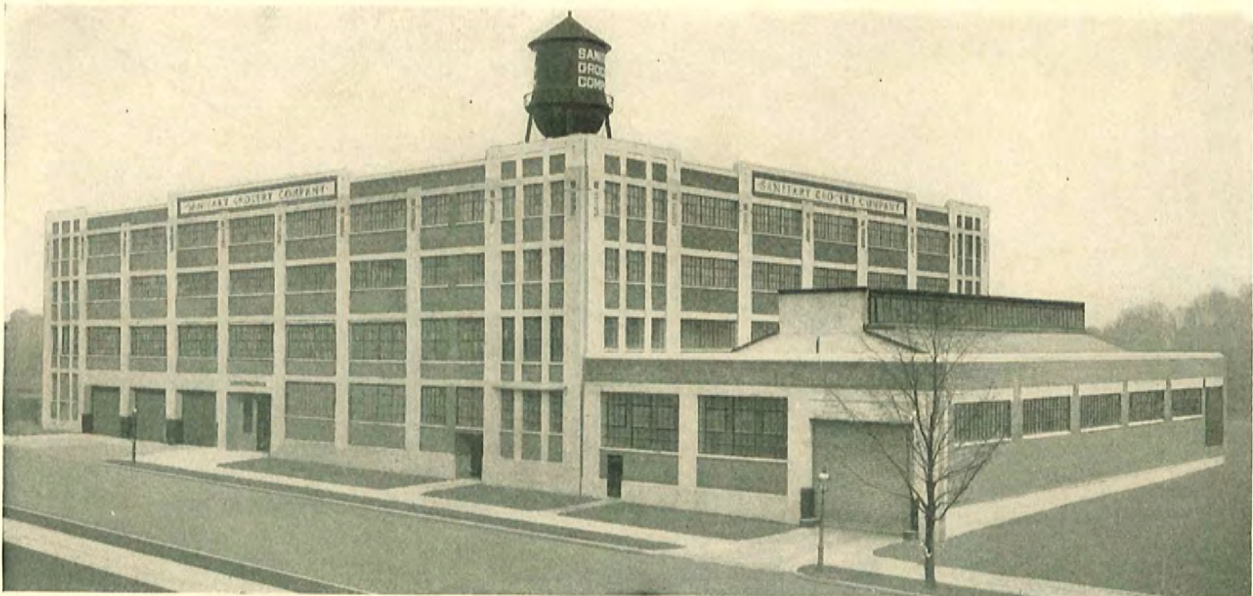

Sanitary Grocery Company
Washington, D. C.

The Ballinger Co., Architects
Chas. H. Tompkins Co., Contractors

Lupton Pivoted Windows are used in all floors of the main building (except the office portion on the second floor), and side walls of garage. Lupton Double Hung Windows were specified for the office, cross muntins being added to agree with the Pivoted Windows in appearance. Pond Continuous Windows are used in the monitor of the garage.

DAVID LUPTON'S SONS COMPANY



Graff Motor Coach Company
Chicago, Ill.

Oman and Lilienthal
Architects

This attractive manufacturing and service building uses Lupton Pivoted Windows in all openings for ample daylight and ventilation. Ventilators are controlled by Lupton Stay Bars.

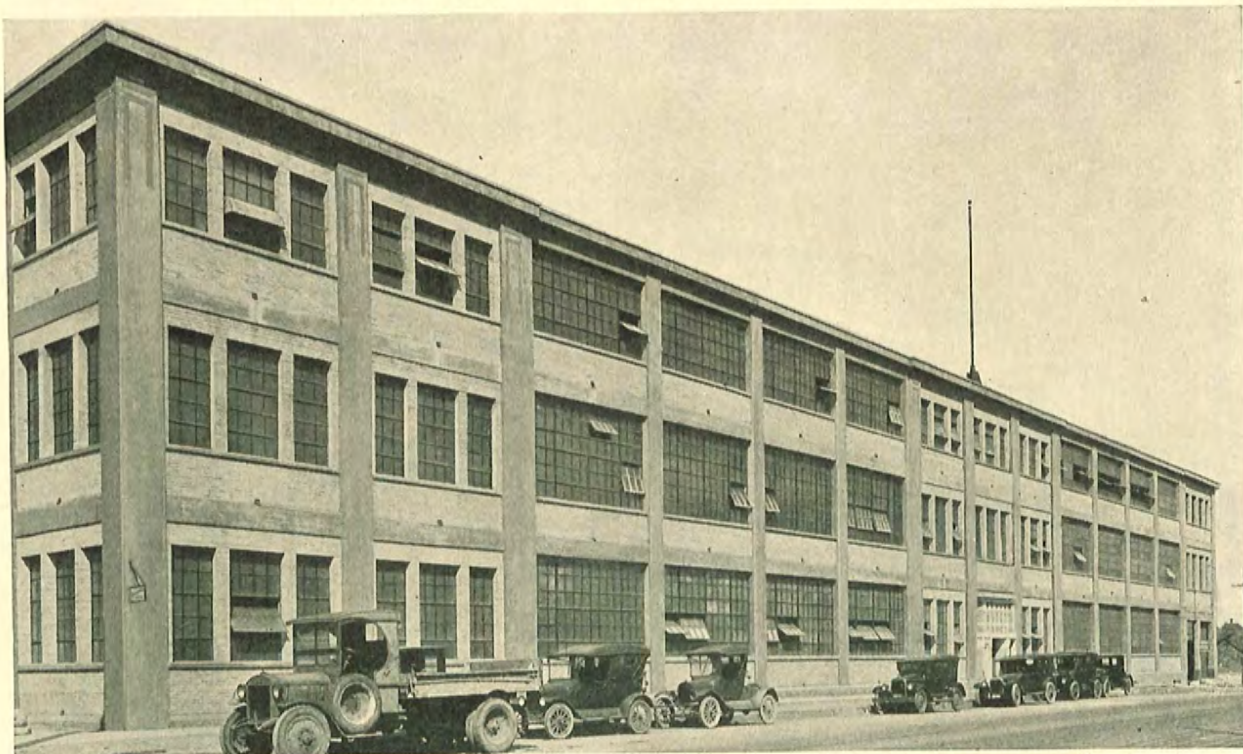

Continental Can Company
Chicago, Ill.

Francisco and Jacobus
Architects and Engineers

A good installation of Lupton Pivoted Windows in a concrete building. Where the upper ventilators occur, they are operated independently of the lower vents.

Standard Camber and Circle Head Windows

Present day design of industrial buildings usually calls for windows having square heads. However, in some types of construction, generally brick, camber and circle heads are still preferred. In many cases, curved heads are specified to carry out the appearance of older buildings in the same group; in others the architectural design will properly use square heads in lower floor units and curved heads above. It is to fill requirements such as these that we offer the standard units shown on the following page.

Through the use of these units, as well as the standard square head units shown elsewhere in this catalogue, the buyer has a wide range of choice that will fill the average demands. Both the camber and circle head units are made to use the same glass sizes as

the standard Lupton Pivoted Windows (12 x 18 in.) and (14 x 20 in.).

All separate camber and circle heads to and including 7 ft. $3\frac{1}{8}$ in. wide (6 lights of glass), are furnished with Lupton section 319 at sill. Where it is required to use separate camber or circle heads of a width greater than 7 ft. $3\frac{1}{8}$ in., Lupton section 308 is used at the sill. This is done to permit attaching to a structural horizontal mullion which is called for when width exceeds the six lights wide dimension. See details, page 38.

Units, other than those shown on page 38, are special, and require a longer time for fabrication and take a higher price. It is well to consult the nearest Lupton branch before departing from the standard sizes.

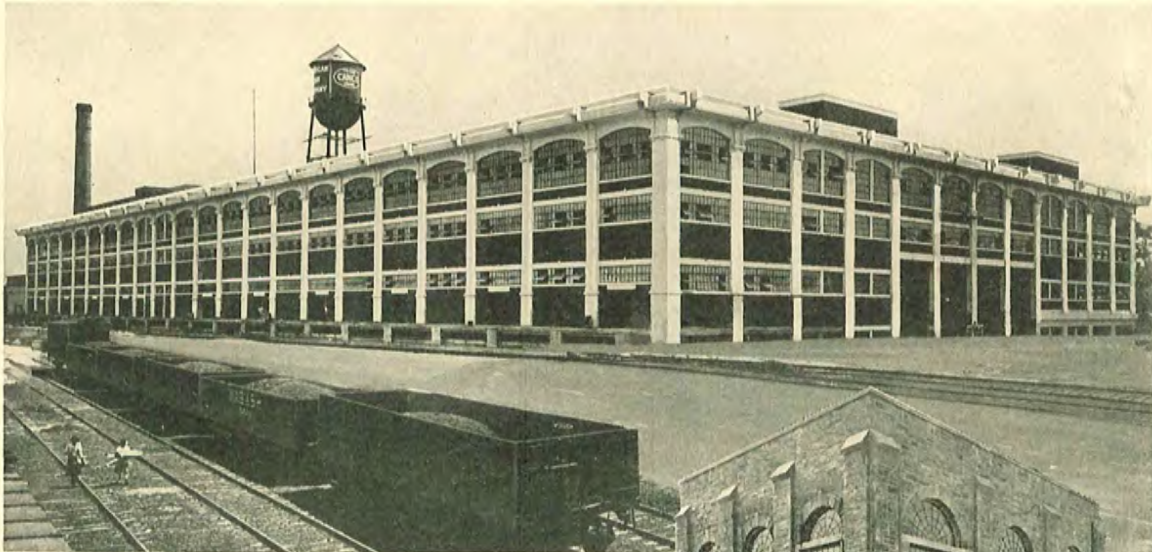

(Above)

American Can Company
Maywood, (Chicago) Ill.

H. M. Lovey
Engineer

Lupton Pivoted Windows are used in the large side wall openings, those in the upper floor having camber heads. This is a good example of the use of square and camber heads in the same building.

(At right)

Philadelphia and West Chester Traction Co.
Sub-Station Drexel Hill, Pa.

This shows the use of circle heads over Lupton Pivoted Windows. In this installation, the curved heads are not an integral part of the window.

STANDARD CAMBER & CIRCLE HEAD UNITS

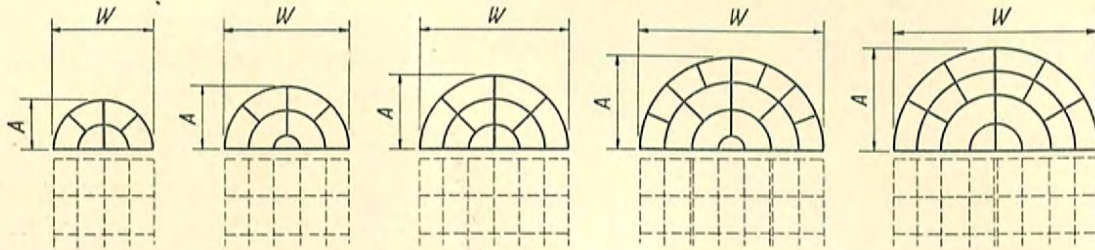

S-42		S-53		S-63		S-74		S-84	
GLASS SIZES-12"x18"		12"x18"		12"x18"		12"x18"		12"x18"	
14"x20"		14"x20"		14"x20"		14"x20"		14"x20"	
W-4'-2 7/8"	4'-10 3/8"	5'-2 3/4"	6'-0 3/4"	6'-3 3/8"	7'-3 3/8"	7'-9 1/4"	8'-11 1/4"	8'-6 3/4"	9'-10 3/4"
A-2'-1 3/8"	2'-5 1/8"	2'-7 7/8"	3'-0 3/8"	3'-1 1/16"	3'-7 3/16"	3'-10 3/8"	4'-5 5/8"	4'-3 3/8"	4'-11 3/8"

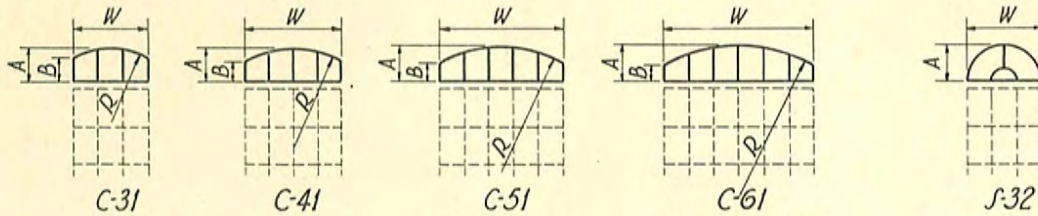

C-31		C-41		C-51		C-61		S-32	
GLASS SIZES-12"x18"		12"x18"		12"x18"		12"x18"		12"x18"	
14"x20"		14"x20"		14"x20"		14"x20"		14"x20"	
W-3'-2"	3'-8"	4'-2 3/8"	4'-10 3/8"	5'-2 3/4"	6'-0 3/4"	6'-3 3/8"	7'-3 3/8"	3'-2"	3'-8"
A-1'-6 1/8"	1'-8 1/8"	1'-6 1/8"	1'-8 1/8"	1'-6 1/8"	1'-8 1/8"	1'-6 1/8"	1'-8 1/8"	1'-7"	1'-10"
B-1'-1"	1'-2 1/4"	0'-11 3/8"	1'-0 5/16"	0'-9 1/16"	0'-10 3/8"	0'-8 1/16"	0'-8 1/16"		
R-3'-2"	3'-8"	4'-2 3/8"	4'-10 3/8"	5'-2 3/4"	6'-0 3/4"	6'-3 3/8"	7'-3 3/8"		

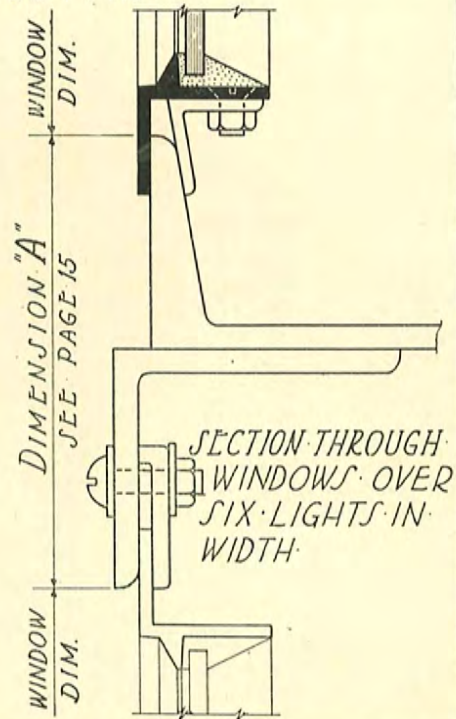
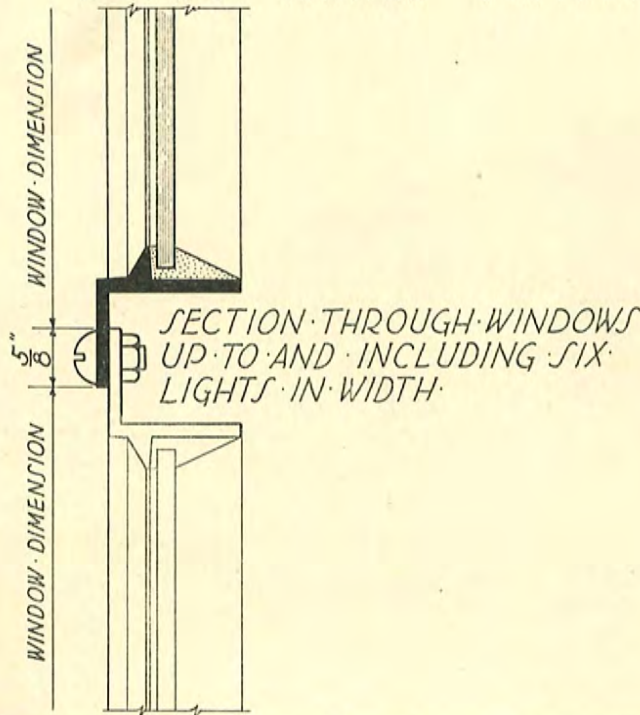

STANDARD CAMBER & CIRCLE HEAD UNITS

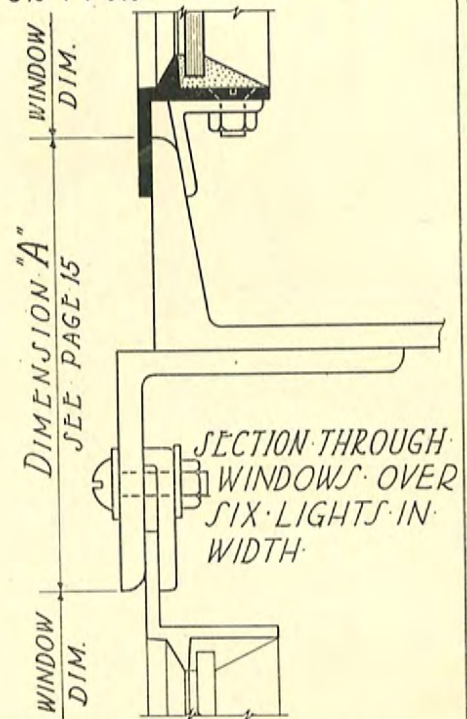
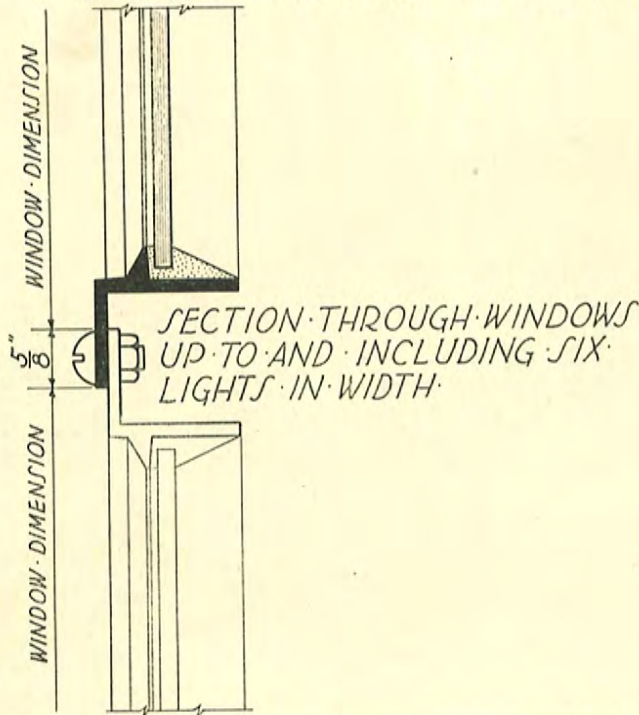
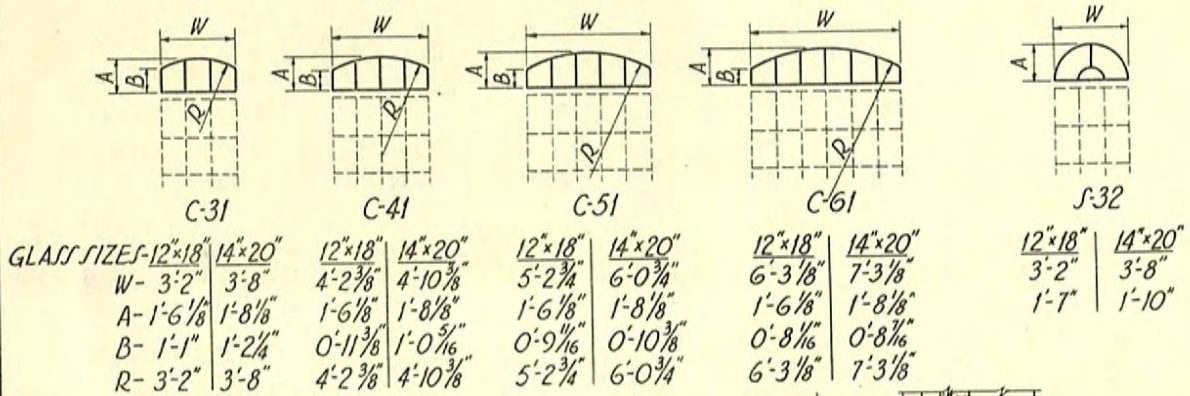
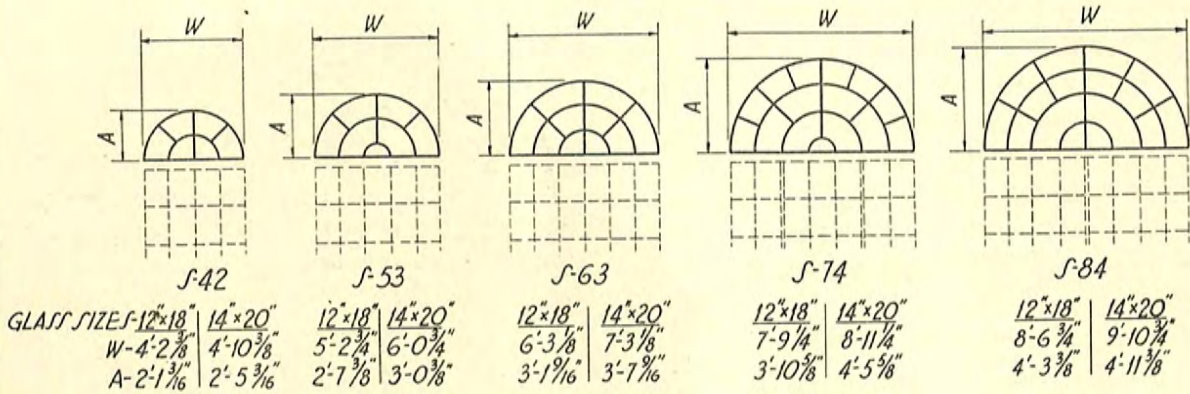

**Explanation of Symbols
shown in diagram on page 38**

Symbols under unit preceded by proper glass size should be used in ordering. All circle head units are preceded by a distinguishing letter S. The camber head units are always distinguished by the letter C. W means width; A is height at center of arch; B is height of sides; R is radius of the camber. Note that Lupton section 319 is used in all units up to 7 ft. $3\frac{1}{8}$ in. wide; section 308 is used in wider units.



Lupton circle head Pivoted Window units,
used in the Acme Power House, Toledo, Ohio

A. Bentley & Sons Co.
Contractors



Lupton Operating Device

Pivoted Window Operators

Lupton Operating Device is a high-grade type of torsion operator in which the inherent weaknesses of the torsion type have been eliminated. It is intended to operate medium length runs of center pivoted sidewall windows and top hung and bottom hinged wood windows. It can be applied with equal satisfaction to existing windows as to a new installation. For lines of windows over 80 ft. or for more than twelve average size ventilators of sidewall windows, and for steel continuous windows, Pond Operating Device (tension type) is always recommended. It is described in another catalogue.

The mechanism of Lupton Operating Device consists of a worm, a segment gear, a torsion shaft, lever arms and vent rods. Two sizes are carried, 1 in., and $\frac{1}{2}$ in. The larger will operate window runs up to 80 ft., 40 ft. each side of the power, or about twelve average size ventilators. The $\frac{1}{2}$ in. size will operate a total length of about 20 ft., or about four average size ventilators. Torsion shaft for 1 in. device is $1\frac{5}{8}$ in. and for the $\frac{1}{2}$ in. device $\frac{7}{8}$ in., both outside dimensions.

Vent rods are flat steel bars. Worm is machine cut from a solid steel bar. Torsion

shaft supporting brackets and power brackets are malleable iron and are designed to fit steel window T-Bar mullions, or may be applied to building structure. Malleable iron is used also for the lighter parts such as vent rod clips; chain guards and other parts are first quality grey iron castings.

Adjustable brackets are provided for torsion shaft when necessary. All brackets are accurately drilled to fit torsion shaft and bronze pins are furnished for connections at each end of vent rods, and in the universal joints. Where hand wheel control is used, the operating rod is a $\frac{3}{4}$ in. round cold rolled steel shaft, supported by adjustable brackets.

Lupton Operating Device is designed to eliminate lost motion and excessive play. In the powers and mitre gear hand wheel control assemblies all bearing surfaces are machined and holes drilled to jigs to insure accurate alignment. All parts are given a shop coat of paint, oven-dried.

Details on following pages cover applications for the most usual conditions. We shall be glad to study your requirements and make the best recommendations.



Lupton Operating Device, controlled by hand chains, is used to operate the upper ventilators of Lupton Pivoted Windows in this drafting room.

OPERATORS WITH HAND CHAIN CONTROL

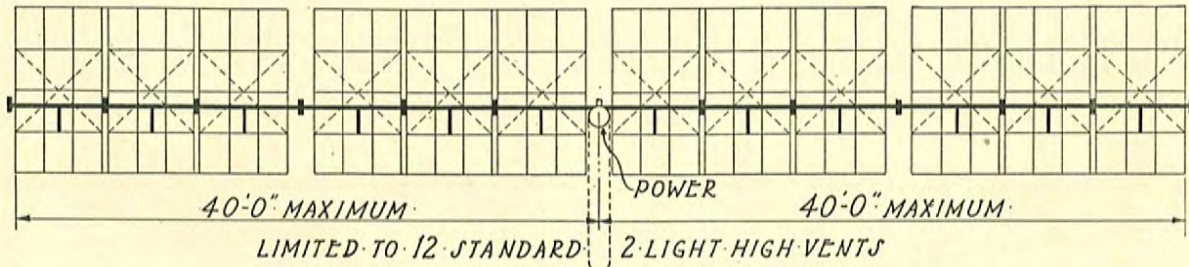

TYPICAL ELEVATION

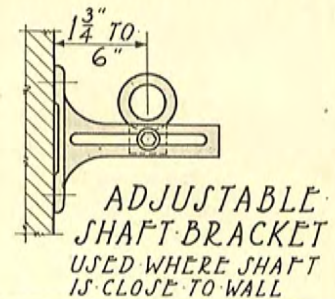
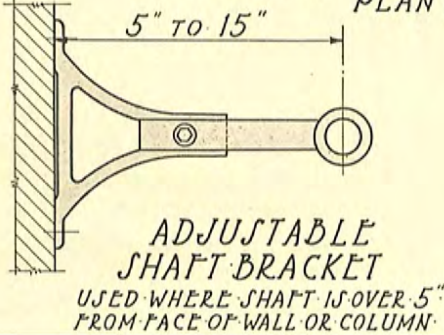
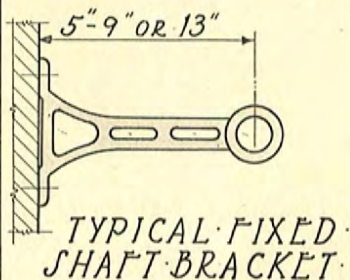
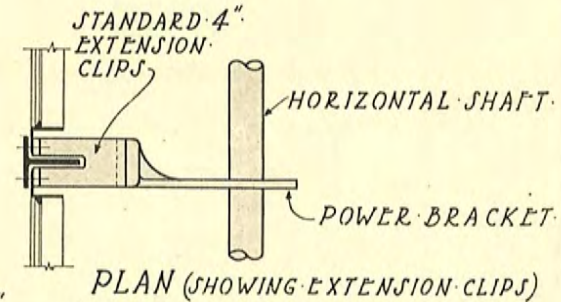
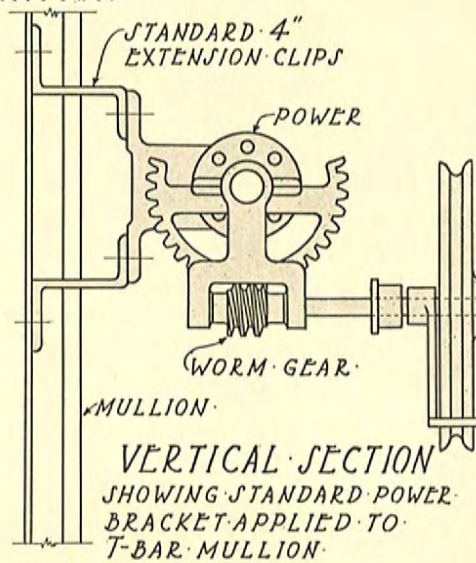
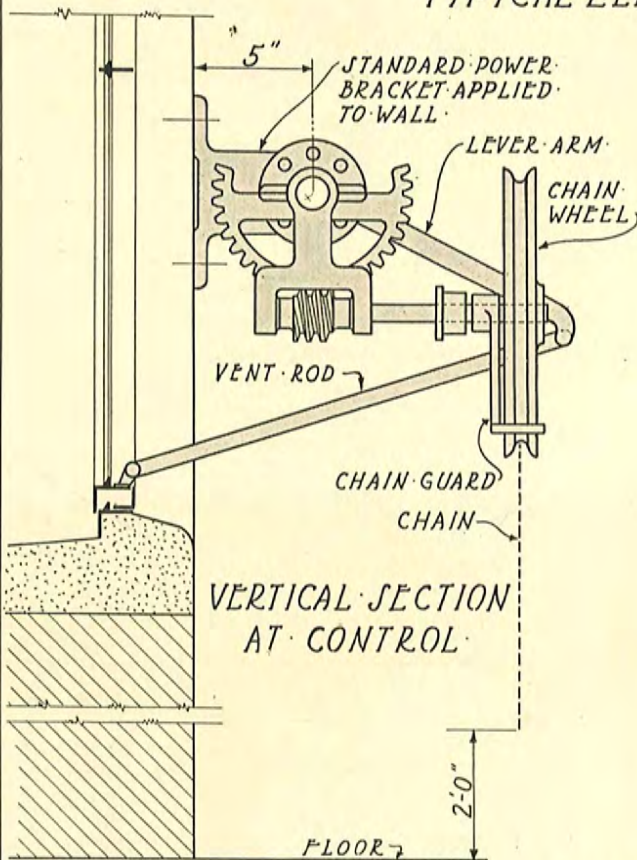

Applications of Hand Chain Control

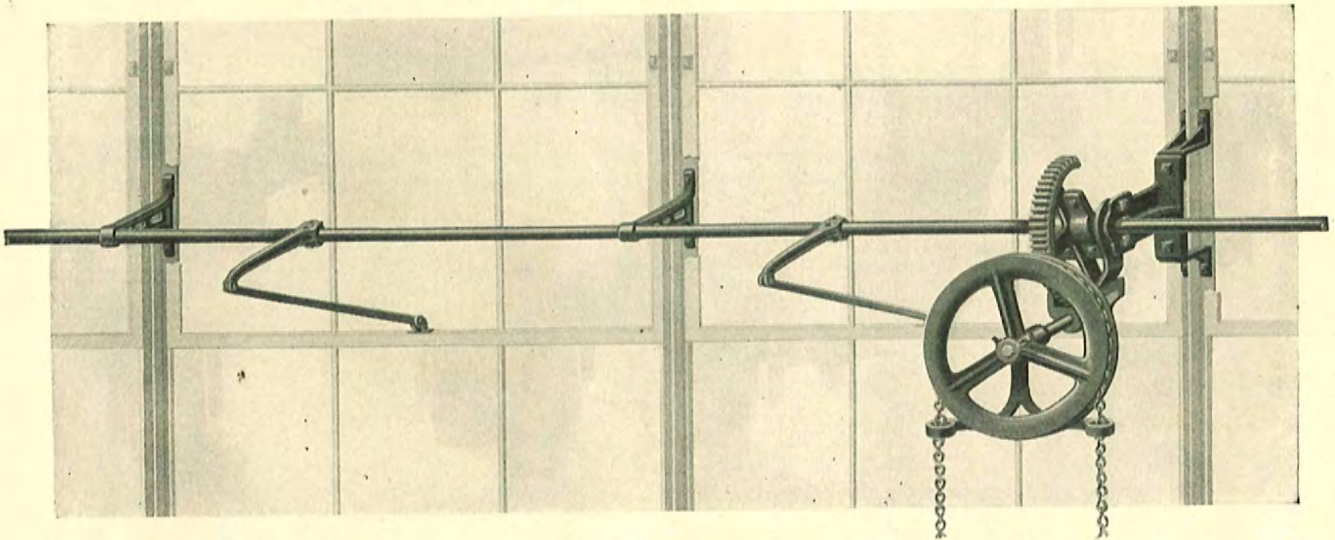

View shows typical installation of Lupton Operating Device, with hand chain control, having shaft brackets attached to the steel window mullions. A standard 5-inch power bracket is used, with the addition of mullion clips, and standard 9-inch fixed brackets are used for connections at the mullions. See details on page 41. Ventilators are shown in closed position.

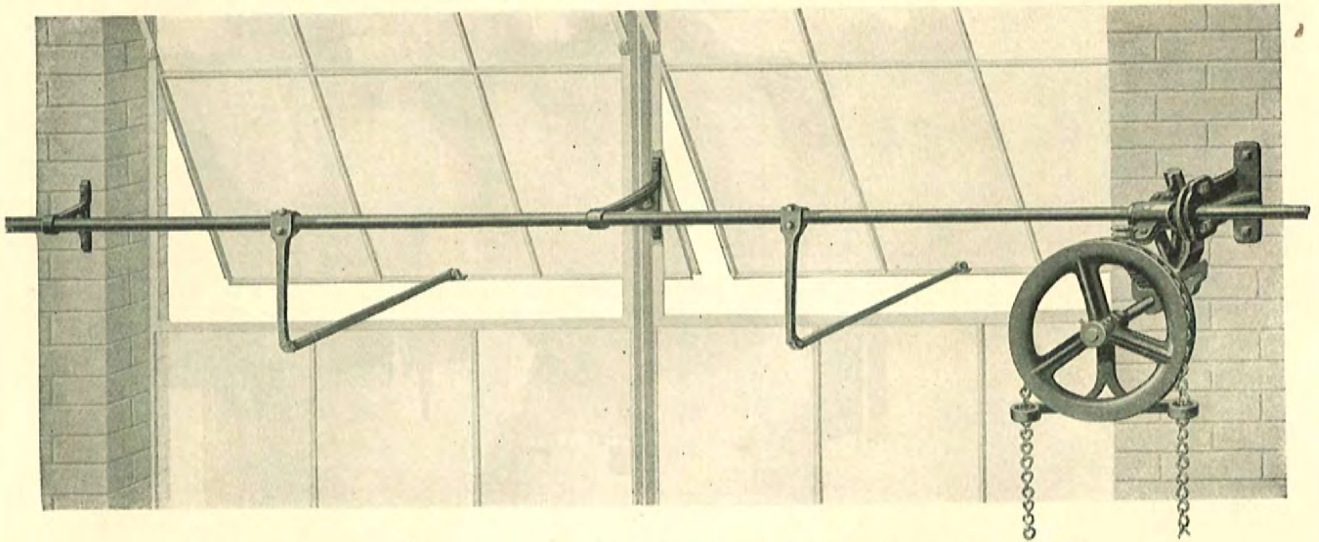

An application of Lupton Operating Device, hand chain control, to Lupton Pivoted Windows. Here the shaft brackets are supported at the wall. See details on page 41. When windows are set 4 or 8 inches from the inside face of the wall, standard 9- or 13-inch fixed brackets may be used at mullions. For special offsets, the adjustable brackets are used at the mullions. The power bracket can be 5 or 7 inches. In this view, the window ventilators are shown in an open position.

Hand Chain Control for Monitor Windows

Photographs and line cross section on this page show method of arrangement of operator chains to clear cranes or other obstructions. This method of control is always recommended for monitor windows.

The hand chain is carried down under the main roof to the side walls by double idlers, provided with chain guards*to prevent chain from slipping off wheels. A single

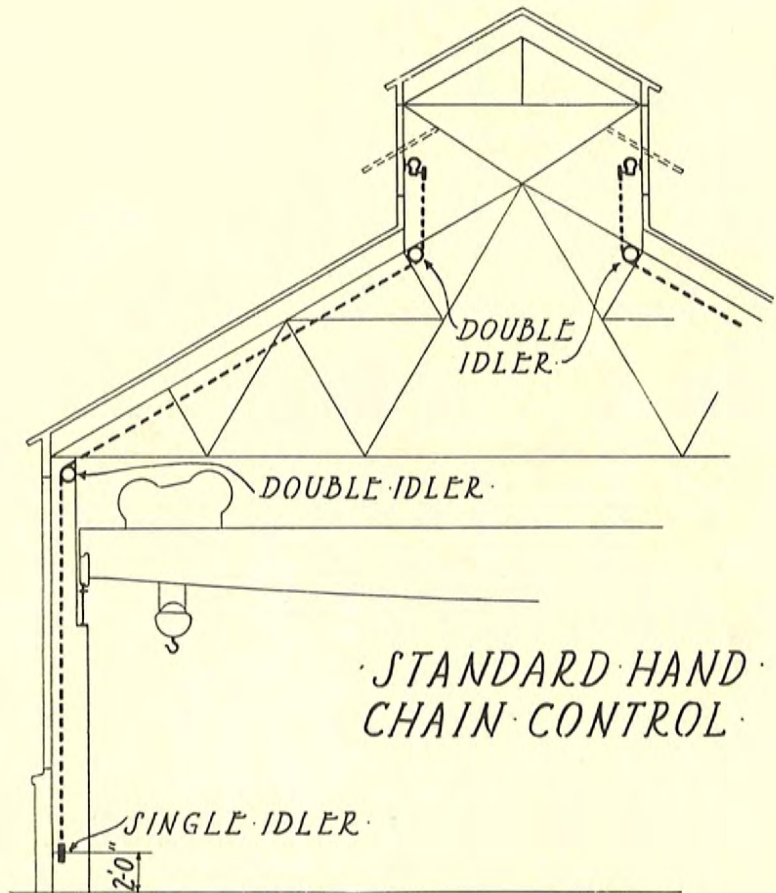
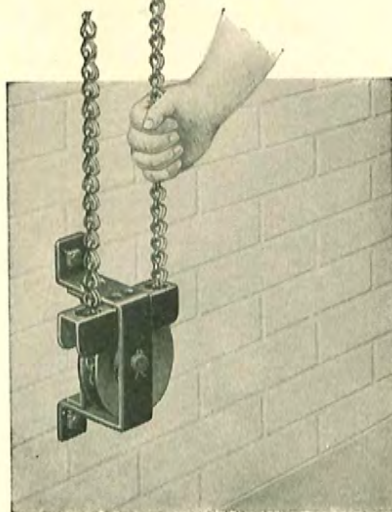
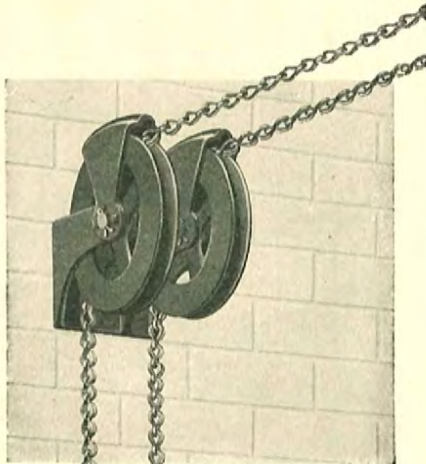
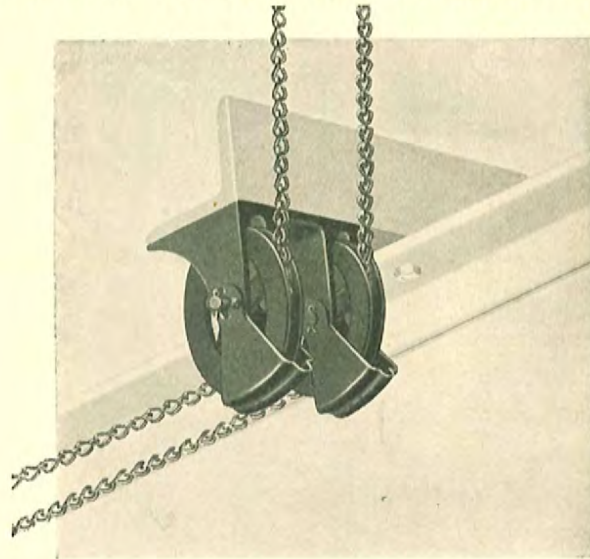

idler at the operating station insures against the chain being pulled up out of reach by the weight of the horizontal run of chain.

Hand Wheel Control for Monitor Windows

An alternate to the method shown on page 43. In this arrangement, the operating shaft is carried from the power to the operating station by adjustable brackets, supported at intervals of 6 feet. We recommend that the hand wheel control be in horizontal plane.

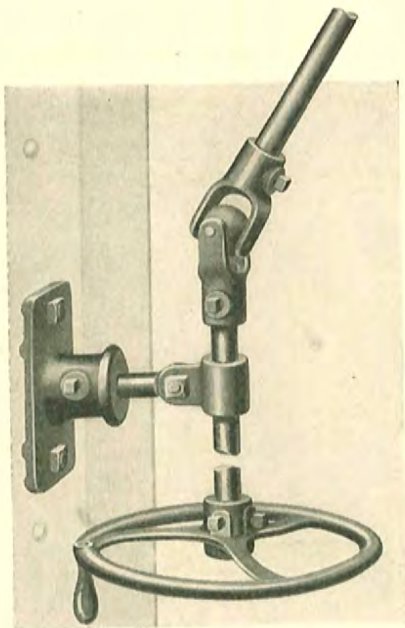
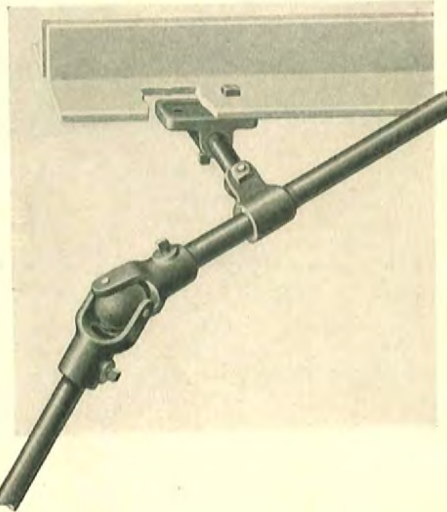

In this type of Lupton Operating Device, the universal joints must not be deflected more than 45° from a straight line.

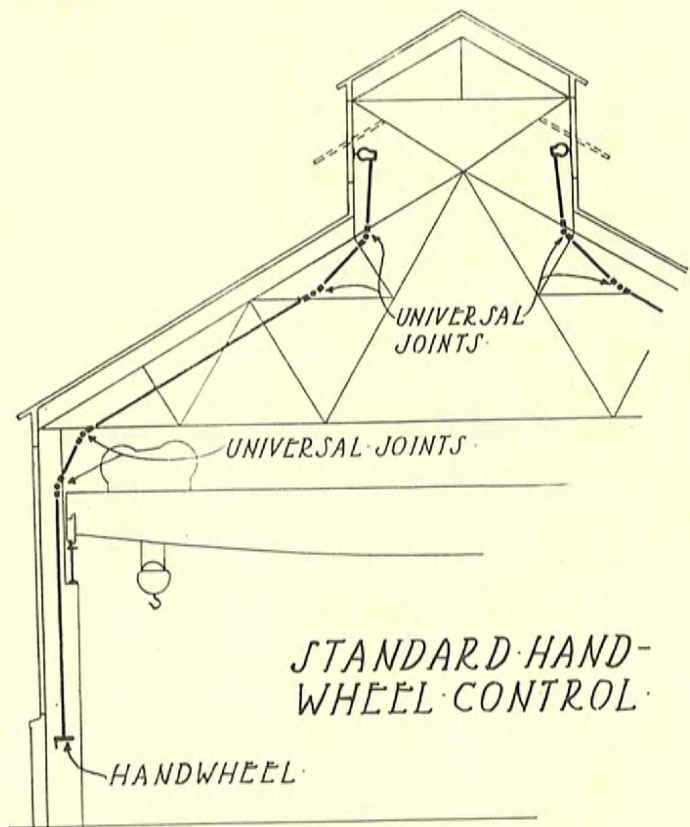

The adjustable brackets for carrying the operating shaft are designed for attaching to columns or truss members. In photograph at top, one is shown attached to a truss member; view at left shows one attached to a column.

OPERATORS WITH HAND WHEEL CONTROL

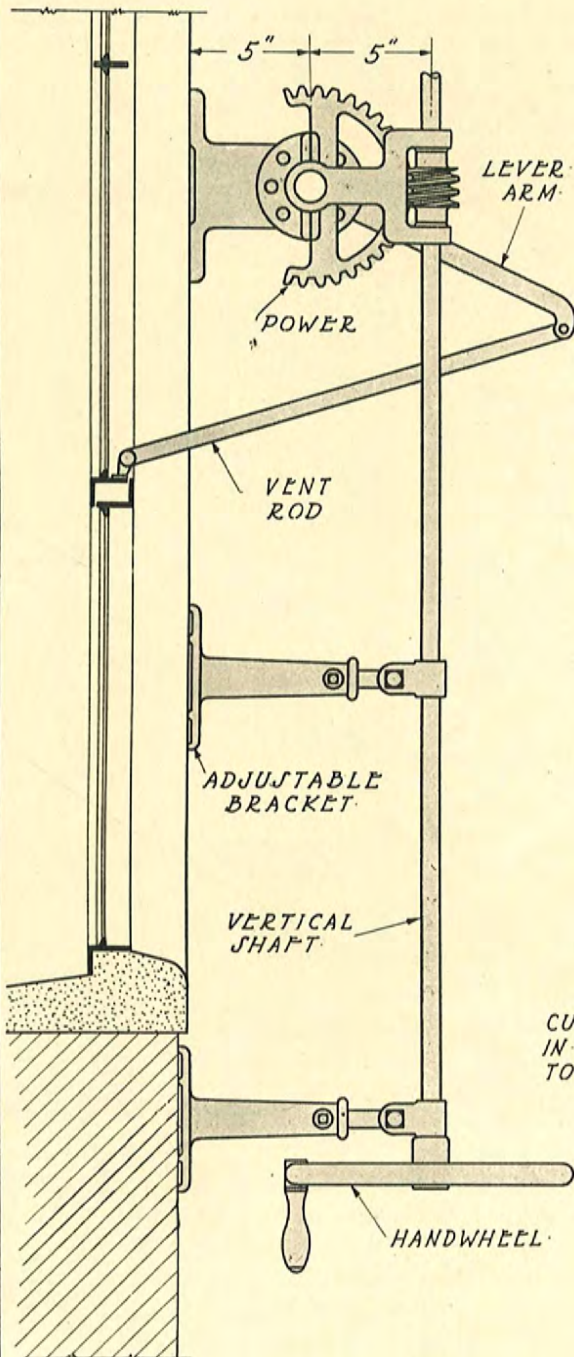

VERTICAL SECTION AT
HANDWHEEL CONTROL

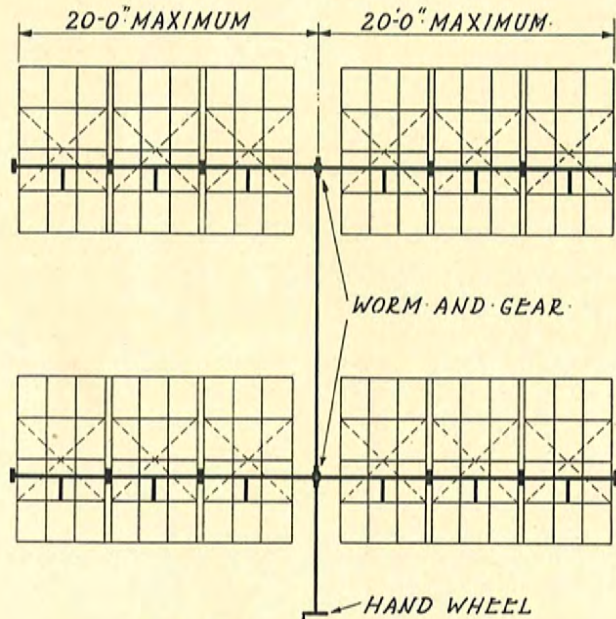

TYPICAL ELEVATION

LIMITED TO 12 STANDARD 2 LIGHT HIGH
VENTS FOR EACH HAND WHEEL CONTROL

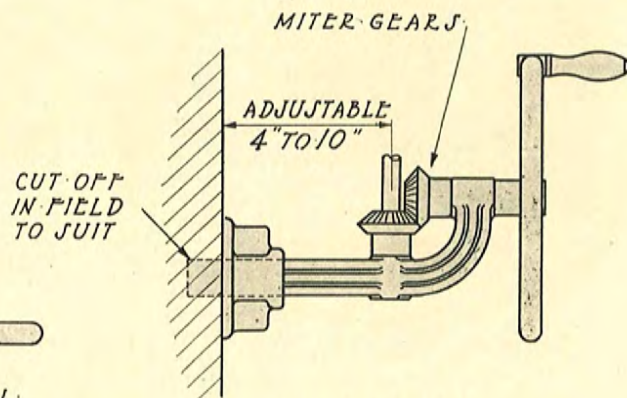

ALTERNATE
HANDWHEEL CONTROL

NOTE:- THAT THE SUPPORTING ARM
FOR THE MITER GEAR HAND WHEEL
ASSEMBLY IS ADJUSTABLE: THE
PORTION WHICH PROJECTS THROUGH
THE BASE (SHOWN IN DOTTED LINES) IS TO
BE CUT OFF IN THE FIELD TO SUIT

Applications of Hand Wheel Control

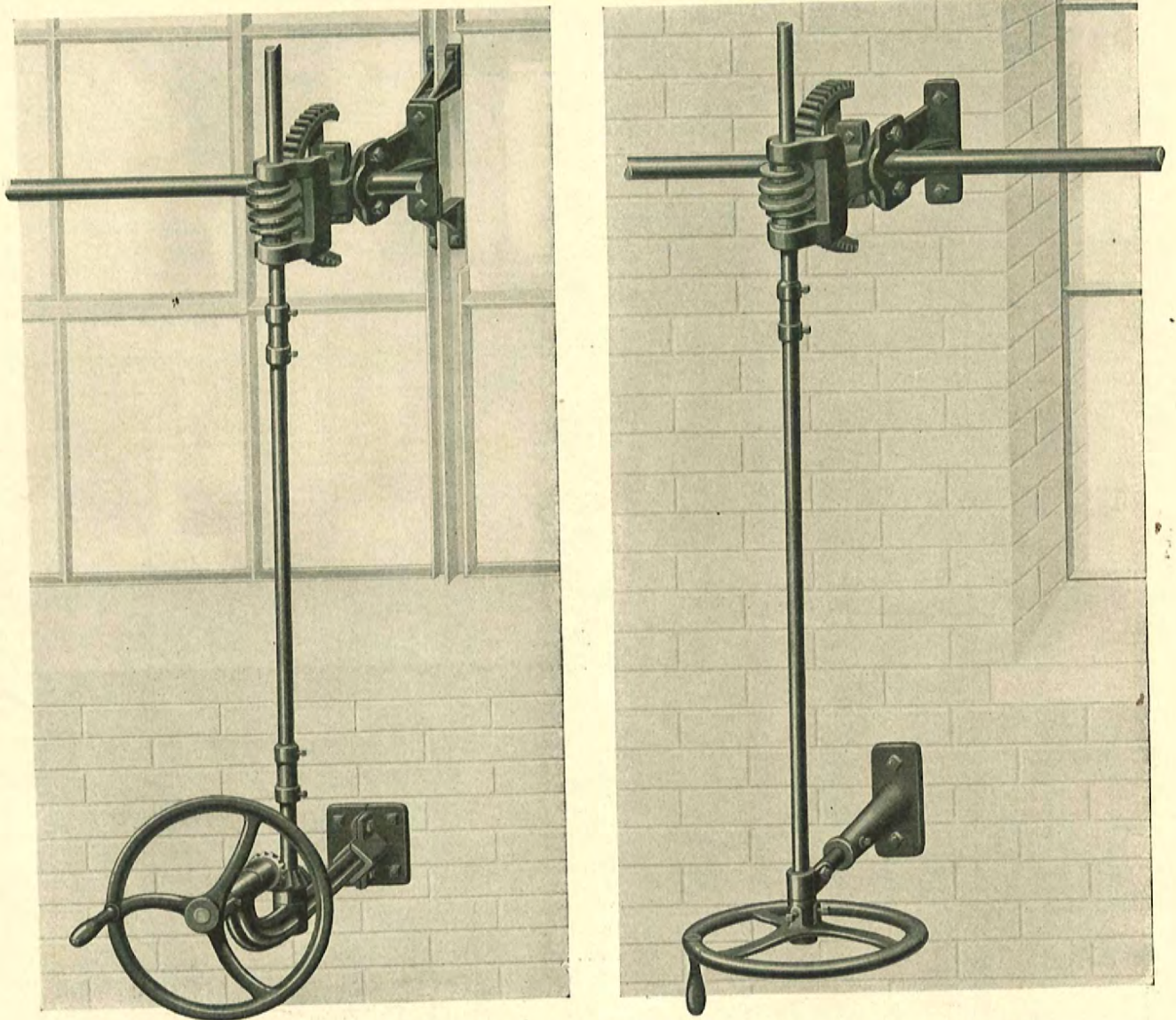

Views of power of Lupton Operating Device, Hand Wheel Control. This is the usual method of operation when it is desired to operate several tiers of ventilators from one station. Where space permits, the hand wheel in horizontal plane (view at right) is more efficient and economical than the mitre gear hand wheel assembly (left). The operating rod is $\frac{3}{4}$ -inch round cold rolled steel and is supported every 6 feet by adjustable brackets. When desired we furnish a cast iron housing for the mitre gears with hand wheel in a vertical plane.

The views above show the two methods of attaching the power brackets, that at the left being to a standard Lupton Steel Window Mullion and the other to a brick wall.

APPLICATION TO PIVOTED & SPECIAL WINDOWS.

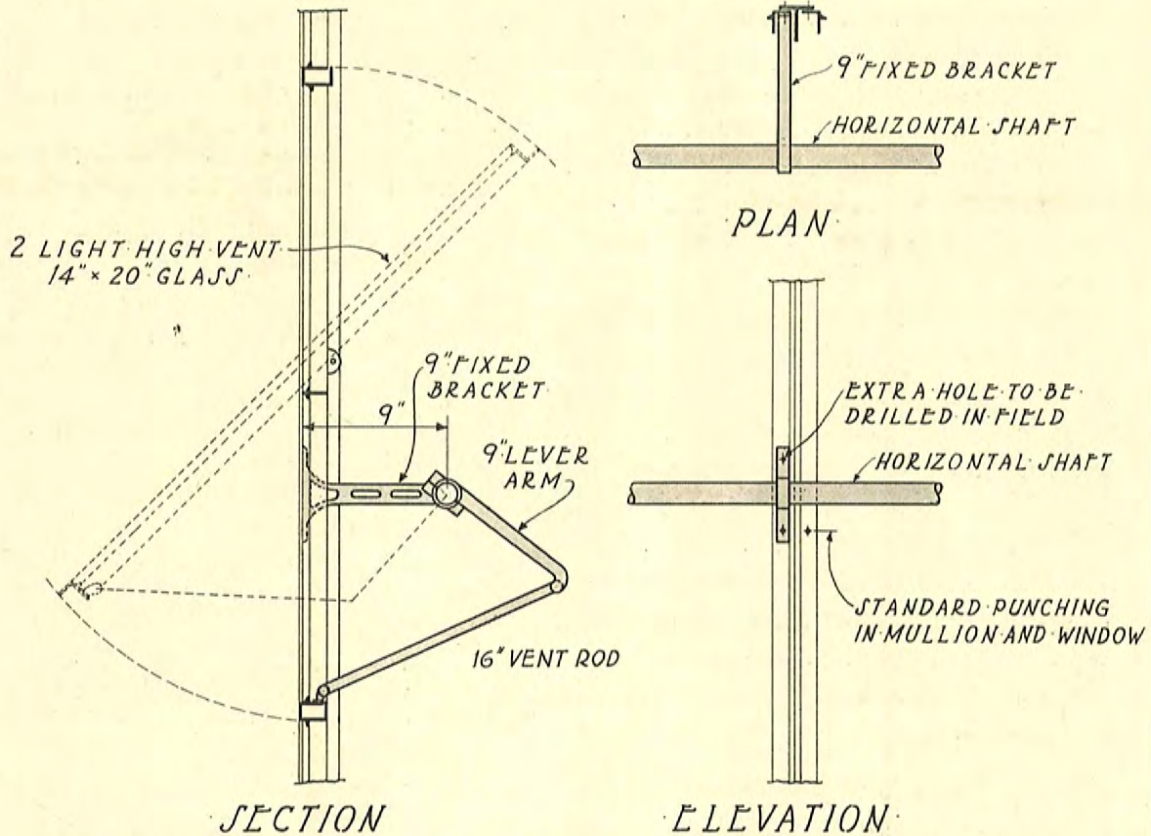

THE ABOVE SKETCH SHOWS A TYPICAL ARRANGEMENT FOR OPERATING STANDARD LUPTON PIVOTED WINDOWS BY USING 9" FIXED BRACKETS. IT IS POSSIBLE TO APPLY THE POWER TO MULLIONS USING EXTENSION CLIPS AS SHOWN ON PAGE 38. FIELD LABOR IS REDUCED AS ONE OF THE MULLION BOLT HOLES IS USED FOR ATTACHING BRACKET.

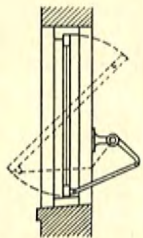

CENTER PIVOTED

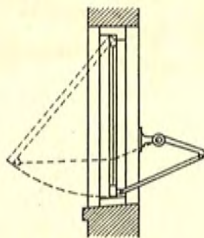

TOP HUNG

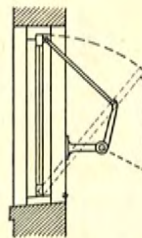

OPEN IN AT TOP

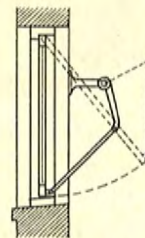

OPEN IN AT BOTTOM

TYPICAL APPLICATIONS TO WOOD WINDOWS.

THE DEVICE CAN BE APPLIED IN VARIOUS WAYS TO TAKE CARE OF SPECIAL CONDITIONS AS SUGGESTED ABOVE. THE STANDARD 5" BRACKET FOR SUPPORTING SHAFT SHOULD BE USED WHERE POSSIBLE IN ORDER TO PERMIT USE OF STANDARD POWER BRACKET.

Lupton Commercial Steel Doors

For all commercial uses, Lupton Commercial Steel Doors will prove to be a permanent investment. Sturdily built throughout and easy to obtain and install, they represent a high class standardized product. They are being widely used in manufacturing plants, private and public garages, and buildings of all sorts, giving exceptional service under all conditions. Their low cost is possible because of large production and close adherence to a standard design.

Construction

The door stiles are made from 18 gauge steel plate, with the corners welded for rigidity. The lower panel is 16 gauge steel plate. Standard doors have glass lights in upper section, with solid steel plate below. Two types of doors are available, hinged and sliding.

The Lupton method of building these doors insures a finished product which cannot warp, swell or twist out of line. They open and close as easily after long use as they do when originally installed.

Details and Sizes

Details and standard sizes of the hinged doors are shown on page 50; of the sliding type on page 51. There are five sizes of single leaf doors in each style. Chart of sizes shows how these can be arranged in pairs.

Hardware

Lupton Commercial Steel Doors include only the hinges for hinged doors and tracks and hangers for the sliding type. Other hardware, including locks, pulls, top and bottom bolts and frame and door stops must be specified in the order if wanted with the doors. When mortise lock No. 97 is ordered with doors, they will be mortised and drilled by Lupton to receive it. When doors are shipped mounted in frame we drill and attach hinges. Otherwise holes for attaching astragals, hinges and other hardware are drilled by the user.

Following is a list of hardware which can be furnished on order. See illustrations on page 49. Specify items by the numbers:

For Hinged Doors

- No. 97 Mortise Lock
- No. 98 Lever Latch and Padlock Bracket
- No. 99 Offset Hinge
- No. 100 Top and Bottom Bolt Assembly
- No. 101 Hook-Back and Ring Assembly

For Sliding Doors

- No. 102 Track Bracket
- No. 103 Track, 8' 0" Long
- No. 104 Trolley Bracket
- No. 105 Trolley
- No. 106 Stay Roller
- No. 107 Center Guide and Stop
- No. 108 Door Stop
- No. 109 Inside Handle
- No. 110 Outside Handle
- No. 111 Hasp and Staple

Astragals

For Either Type

- No. 2392 for 7' 0" Doors Hinged
- No. 2393 for 7' 6" Doors Hinged
- No. 2394 for 8' 0" Doors Hinged
- No. 2395 for 10' 0" Doors Hinged
- No. 2414 for 6' 10 1/2" Doors Sliding
- No. 2415 for 7' 4 1/2" Doors Sliding
- No. 2416 for 7' 10 1/2" Doors Sliding
- No. 2417 for 9' 10 1/2" Doors Sliding

Glass

Glass sizes of lights are given on pages 50 and 51. Orders for doors do not include glass, but we furnish the necessary glazing members. Glazing should be done after doors have been erected.

Information Required with the Order

Indicate the number of door units, either hinged or sliding, required. Each standard unit is marked on detail pages. For example D1 is a single leaf and can be of either type. D21 represents two single-leaf doors. The swing of the doors should always be mentioned. If hardware is wanted, specify the items by number from list above and we will furnish the proper quantity to fill out the order.

Hardware for Lupton Commercial Steel Doors

In keeping with the sturdy, yet attractive appearance of Lupton Commercial Steel Doors, the hardware has been designed from the standpoint of service as well as appearance.

are furnished only on order when specified. See under "Hardware" on page 48 for mortising and drilling.

For your convenience in ordering, the hard-

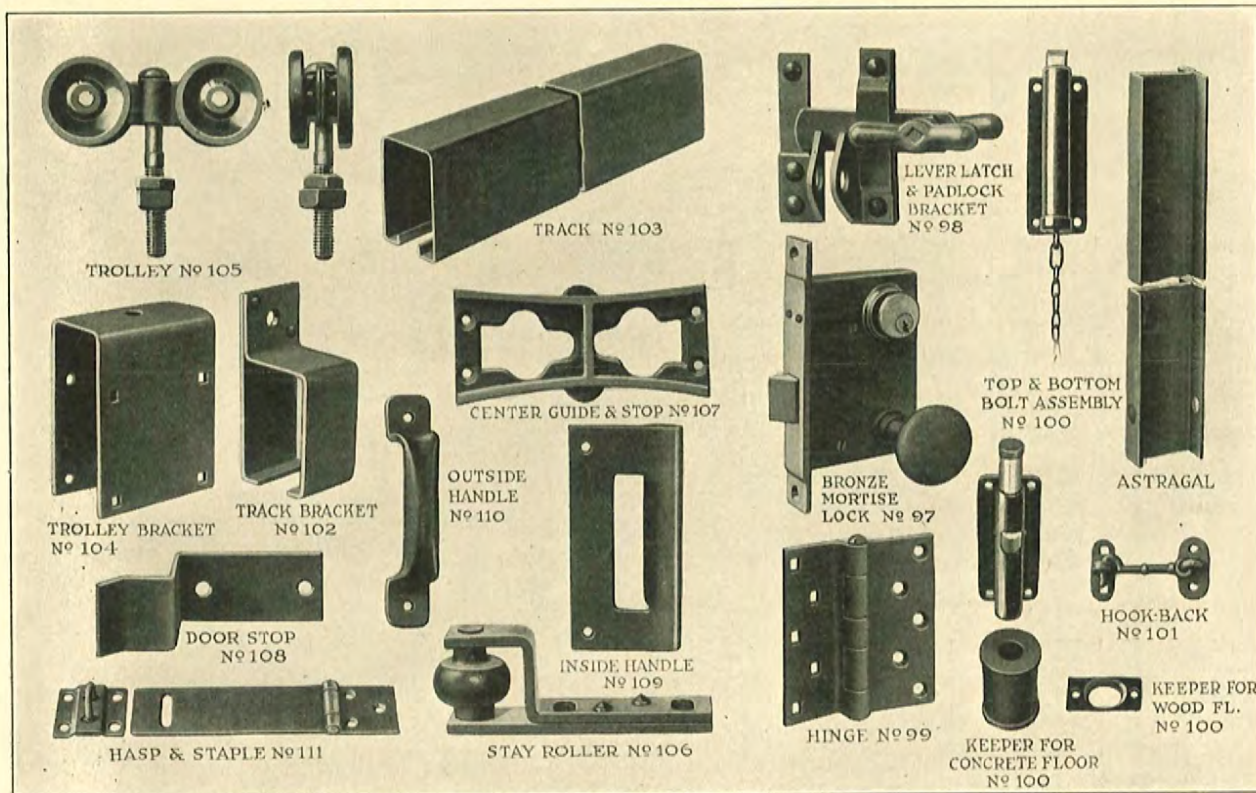

For good service, a door requires hardware that is heavy enough to stand up under hard use and the hardware shown in illustration above will fill every need called for.

In the reproduction above, the hardware items in the space to the left of the center are for sliding doors; those at the right are for the hinged type. It should be remembered that only tracks and hangers are furnished with orders for the sliding type and hinges with hinged doors. All other hardware items

ware shown in the photograph is listed on page 48.

When hardware is wanted, indicate the items wanted by name and number. Sufficient quantity of each will be furnished to fill your requirements, together with the necessary screws or bolts for attaching.

Hardware shown is standard and can be furnished from stock. Special types will necessitate delay in delivery and an increase in the price.

SLIDING DOORS - SIZES & DETAILS

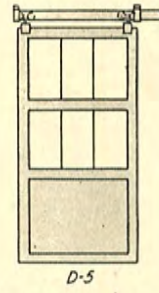
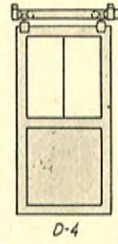
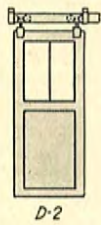
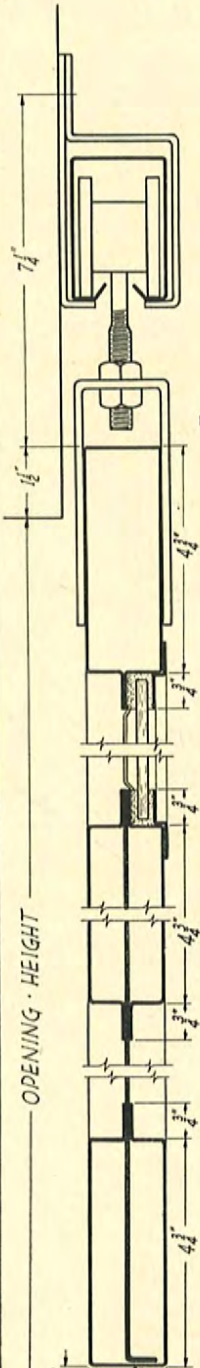

SINGLE DOORS

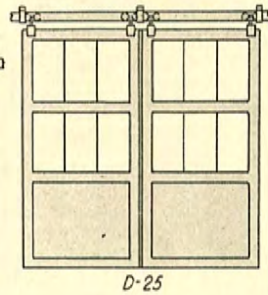
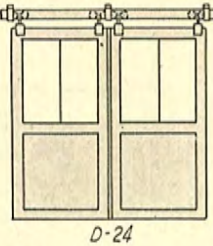
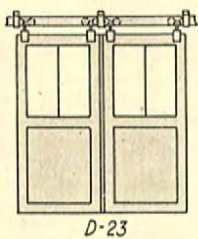
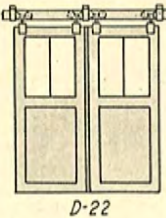
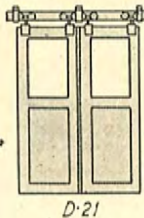

DOUBLE DOORS

STANDARD SIZES

DOOR MARK	OPENING HEIGHT	OPENING WIDTH	GLASS SIZES	CATALOGUE NO. for ASTRAGAL
D-1	6'-10 1/2"	2'-3"	1-19 7/8" x 30 1/2"	
D-2	6'-10 1/2"	2'-9"	2-12 3/8" x 30 1/2"	
D-3	7'-4 1/2"	3'-3"	2-15 3/8" x 36 1/2"	
D-4	7'-10 1/2"	3'-9"	2-18 3/8" x 42 1/2"	
D-5	9'-10 1/2"	4'-9"	6-16 1/4" x 30 3/4"	
D-21	6'-10 1/2"	4'-9"	2-19 7/8" x 30 1/2"	# 2414
D-22	6'-10 1/2"	5'-9"	4-12 3/8" x 30 1/2"	# 2414
D-23	7'-4 1/2"	6'-9"	4-15 3/8" x 36 1/2"	# 2415
D-24	7'-10 1/2"	7'-9"	4-18 3/8" x 42 1/2"	# 2416
D-25	9'-10 1/2"	9'-9"	12-16 1/4" x 30 3/4"	# 2417

NOTES

WHEN DOORS SLIDE ON OUTSIDE OF BUILDING FLASHING IS NOT BY LUPTON
TWO OR MORE UNITS MAY BE UNITED INTO SINGLE LEAVES FOR WIDER OPENINGS THAN SHOWN IN THE TABLE.

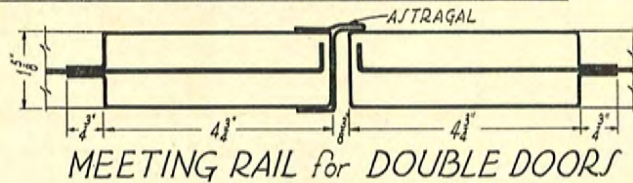

MEETING RAIL for DOUBLE DOORS

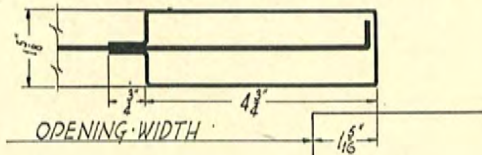

HORIZONTAL SECTION SINGLE OR DOUBLE DOORS

VERTICAL SECTION for SINGLE & DOUBLE DOORS

OTHER LUPTON PRODUCTS

Lupton Residence Casement Windows



Made from one-piece copper steel members, with extended hinge which permits cleaning both sides of the glass from within the room. We also make Steel Basement Windows.

Lupton Counterbalanced Windows

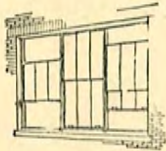

These windows make balanced ventilation automatic. When the lower window is opened, the upper window lowers an equal distance, thus providing an entrance for fresh air and an exit for exhausted air at the same time.

Lupton Double Hung Windows

A practical, good-looking, easy-moving window for office buildings, hotels and apartments. Weather-tightness is assured by the carefully designed construction of galvanized steel plate. Low cost is due to quantity production.



Lupton Projected Windows

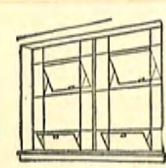

First made by Lupton, this type of window has met with constantly increasing popularity for factories, office buildings and schools. Easily operated ventilators stay open in any position. Made in Architectural and Commercial types.

Pond Continuous Windows

This window forms a transparent, weather-protecting shelter over a continuous opening, and gives remarkable efficiency in the natural lighting and ventilation of industrial buildings. Long runs are readily controlled by Pond Operating Device.



Pond Operating Device

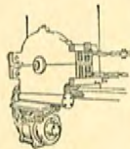

Employing the tension principle, Pond Operating Device has no equal for operating runs of top-hung windows or large groups of pivoted windows. Free from useless stresses. Gives efficient mass control and exceptionally long service.

Lupton Steel Factory, Store and Office Equipment

Lupton Factory Equipment solves the problems of industrial furniture. Made of smooth, durable steel, Lupton Shop Desks, Bench Legs, Bench

Lupton Casements Heavy Type

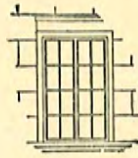

The highest grade steel windows for banks, libraries, clubs, office buildings or fine residences. They are made in six standard types, and can be furnished to suit any size or shape of opening.

Burvett Steel Doors

These multiple-leaf, vertical-lift doors give long, efficient service. Door does not roll or fold. Panels telescope vertically. Operation is by hand chain or motor.



Lupton Industrial Steel Doors



Ideal for the inside and outside doors of factories, power-houses, warehouses and other industrial buildings where great strength and rigidity are required. They are made from seamless steel tube, oxy-acetylene welded throughout.

Lupton Steel Partition

Lupton Steel Partition is strong, rigid, and dignified in appearance. Bolted construction makes it readily removable in units. Interchangeability is assured by standard heights and widths of units. Easy to keep clean.



Lupton Rolled Steel Skylight



Built to stand severe service. Glass is held between strips of specially treated fibre, eliminating breakage due to vibration and wide range of temperature. The cap is either of copper or galvanized steel, the base of steel.

Lupton Steel Shelving

A type suited to every storage requirement. Storage Shelving for mills; Display and Unit Shelving for stores and offices; Racks for special requirements; all cut maintenance costs, conserve floor space and simplify store keeping.



Drawers, Tool Cabinets, Utility Cabinets, Display Counter, etc., give lasting investment value. Easily kept clean.

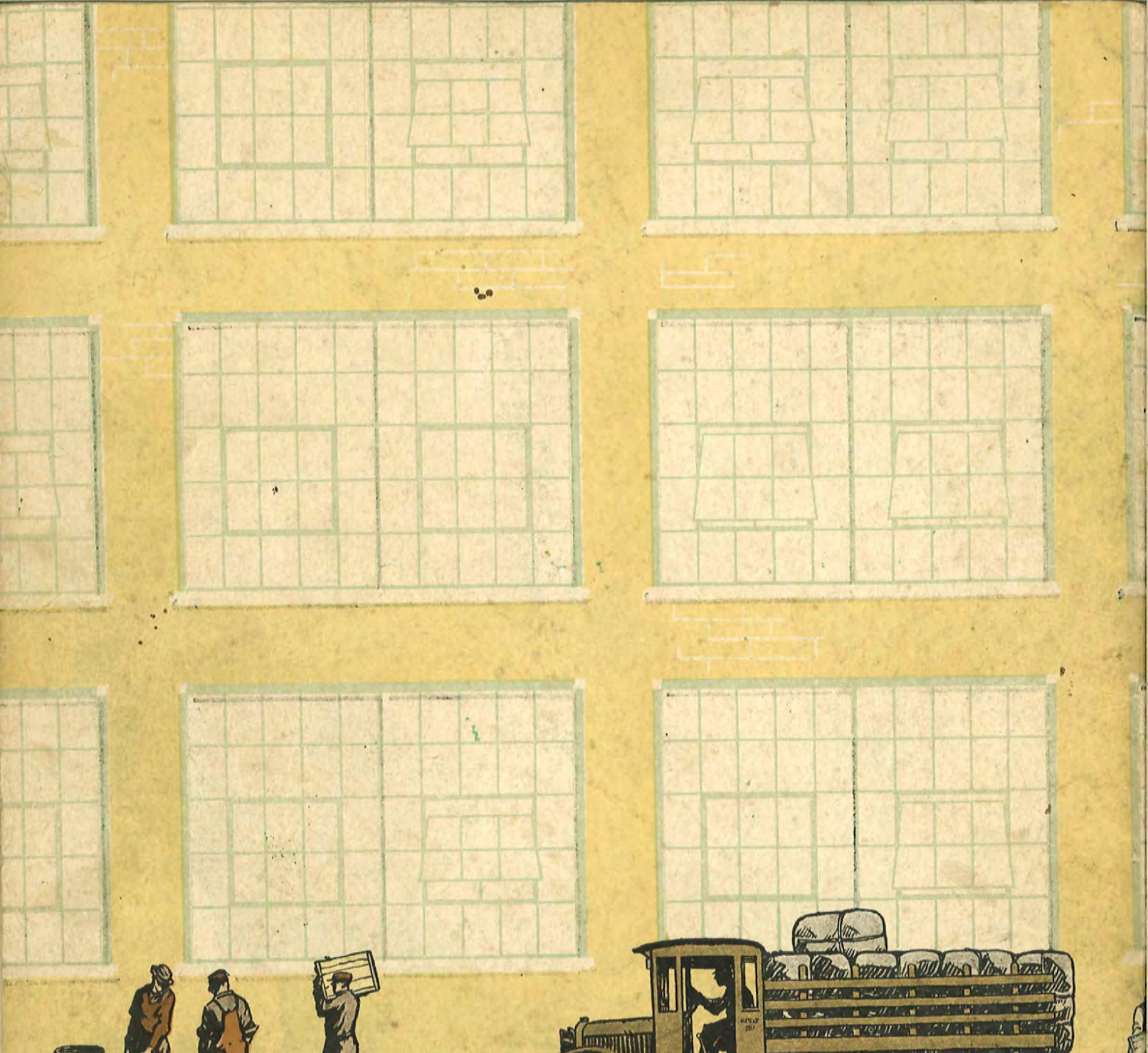

"everywhere"

Made in U.S.A.